

Crowcon Gasmaster

1 to 4 channel gas detection control panel



Installation, Operation and Maintenance Manual

The equipment described in this manual may have mains voltages applied to it. Ensure correct safety procedures are adopted before working on the equipment.

The equipment described in this manual is designed for the detection of flammable and/or toxic gases. Detectors may be sited in hazardous areas. Ensure local safety procedures are adopted before carrying out any maintenance or calibration work.

The equipment described in this manual may be connected to remote alarms and/or shutdown systems. Ensure that local operating procedures are adopted before carrying out any maintenance or calibration work.



This product has been tested and found to comply with the European Directive 2004/108/EC and the EMC requirements of EN50270. It also complies with the Council Directive 2006/95/EC relating to electrical safety and the Low Voltage Directive. It conforms to the CE Marking Directive 93/68/EEC.



Passed inspection by	Date
----------------------	------

Tested for electrical safety by	Date
---------------------------------	------

MODEL

Caution: Read and understand manual before operating. Mount outside hazardous area. see manual for relay contact ratings.

Multiple rated voltages: 100-240V
Rated frequency range: 50-60Hz
Rated Current: 1.3A MAX

172 Brook Drive, Milton Park,
Abingdon, Oxon, OX14 4SD, England
Telephone: 01235 557700
Fax: 01235 557749
www.crowcon.com



Crowcon Detection Instruments Ltd
172 Brook Drive, Milton Park,
Abingdon OX14 4SD UK
Tel. +44 (0)1235 557700
Fax. +44 (0)1235 557749
www.crowcon.com
Email: sales@crowcon.com

© Copyright Crowcon Detection Instruments Ltd 2014
All rights are reserved. No part of the document may be photocopied, reproduced, or translated to another language without the prior written consent of Crowcon Detection Instruments Ltd.
Publication number: M070010
second edition: October 2014

Contents

1. Introduction	1	4.2 System Inhibit	35
1.1 About Gasmaster	1	4.3 Detector Calibration	36
1.2 About this manual.	1	4.4 Changing Batteries	36
1.3 Instructions for use as part of an ATEX approved system	2	4.5 Module Replacement	36
2. Installation	3	4.6 Event logging	36
Please read this first.	3	4.7 Service card.	36
2.1 Before installation	4	4.8 Cleaning	36
2.1 General	4	5. Adding an input module.	37
2.3 Mounting	5	Appendix A: Specifications	38
2.4 Cabling requirements	5	Appendix B: Spare Parts and Accessories	39
2.5 Installing gas and fire detectors.	6	Appendix C: Display characters.	40
2.6 Installing output devices	6	Warranty Statement	41
2.7 Connecting mains power	6	Regional addresses	42
2.8 Connecting input devices	7		
2.9 Connecting output devices	11		
2.10 Applying power.	13		
2.11 Battery back-up times	13		
2.12 Commissioning	14		
3. Operation	17		
3.1 Gasmaster Operator Panel.	17		
3.2 Gasmaster start up sequence	19		
3.3 How to adjust display contrast	19		
3.4 How to display Instrument serial number and system identity	19		
3.5 Using the menu system	20		
3.6 Inhibiting channels	20		
3.7 Using the Control Panel in Supervisor Mode	21		
3.8 In the event of an alarm	22		
3.9 mV channels: Pellistor saver mode22			
3.10 In the event of a fault	23		
3.11 System Configuration	23		
4. Maintenance.	35		
4.1 Functional Testing	35		

1. Introduction

1.1 About Gasmaster

Gasmaster is a gas and fire control panel, designed to monitor remote gas and fire detectors. Gasmaster can also monitor flame detectors as well as Crowcon's ESU product. The status of each input is displayed on a large, clear LCD display, and alarms or faults are indicated by clear LEDs and an integral sounder.

Relay outputs are provided for alarms and faults, as well as dedicated outputs for audible visual alarms. An RS-485 Modbus output is provided for two-wire transfer of all data to industry-standard control systems.

Gasmaster logs all alarm and fault events so that they can be investigated at a later stage using Gasmaster PC software.

There are two versions of Gasmaster:

- Gasmaster 1 - single channel unit for one gas detector, fire zone or ESU sampling device.
- Gasmaster 4 - four channel unit for one to four gas detectors, fire zones or ESU sampling devices.

Gasmaster 1 is identifiable from Gasmaster 4 by having only a single channel display (see figure 3.2, page 18) and a de-populated terminal PCB. All operating functions are identical to Gasmaster 4.

Gasmaster is designed for simple operation, and all day-to-day functions can be performed from the front panel. Please refer to section 3 for details on display operation.

1.2 About this manual

The manual is divided into sections which detail procedures for installing, operating and maintaining Gasmaster. Gasmaster is a safety system and it is essential that all instructions are correctly followed.

Details of the types of device that can be connected to Gasmaster are shown in section 2, along with typical connection diagrams. Section

3 provides instructions for day-to-day operation of Gasmaster as well as detailed information on system configuration.

Warning

Regular maintenance of any safety system is essential, and failure to maintain the system according to these instructions could result in failures which could lead to harm to plant and/or personnel or even death. Details of the requirements for Gasmaster systems are provided in section 4.

There are separate appendices for systems specification and spare parts identification.

1.3 Instructions for use as part of an ATEX approved system

Gasmaster is approved according to the 94/9/EC ATEX Directive when used as part of a system with intrinsically safe gas detectors and I.S. barriers.

Gasmaster has been certified according to EN60079-25:2010 Explosive atmospheres - Intrinsically safe electrical systems.

Certificate reference: Baseefa05Y0090/1

Gasmaster must be installed in the safe area only, but is certified for connection to Intrinsically Safe gas detectors installed in Zone 0, 1 or 2 hazardous areas when connected by a safety barrier. Installation must be in accordance with the instructions shown below.

EXAMPLES OF SAFE AREA APPARATUS			
CROWCON GASMOMITOR SYSTEM			
CROWCON GASMMASTER SYSTEMS			
CROWCON VORTEX SYSTEMS			
IT IS THE RESPONSIBILITY OF THE INSTALLER TO ENSURE THAT THE EQUIPMENT ABOVE COMPLIES WITH NOTE 7.			

TABLE 1: CABLE PARAMETERS			
GROUP	CAPACITANCE uF	INDUCTANCE mH	L/R RATIO uH/OHM
TXGARD IS+ TOXIC OR OXYGEN GAS DETECTOR - BASEEFA 08ATEX0069X			
IC	0.062	3.11	53
IB	0.186	9.35	200
IIA	0.496	24.95	422
XGARD TOXIC OR OXYGEN GAS DETECTOR - BASEEFA 04ATEX0115			
IC	0.046	3.09	53
IB	0.170	9.33	200
IIA	0.480	24.93	422
TXGARD IS TOXIC GAS DETECTOR - BASEEFA 03ATEX0063X			
IC	0.009	4.2	53
IB	0.133	12.6	200
IIA	0.443	33.6	422
TXGARD IS OXYGEN GAS DETECTOR - BASEEFA 03ATEX0062X			
IC	0.024	4.2	53
IB	0.148	12.6	200
IIA	0.458	33.6	422

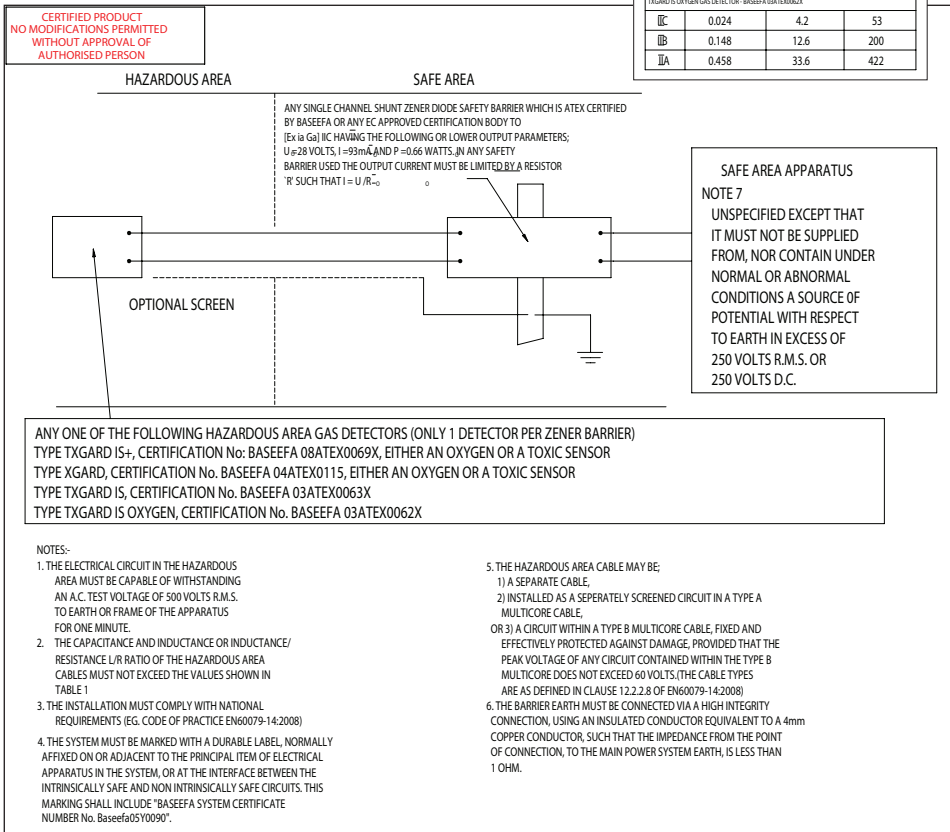

2. Installation

Please read this first

Before commencing the installation and commissioning of your Gasmaster system, please read through the following information which will guide you through the whole process.

The installation instructions contained in this section are for a pre-configured **Gasmaster**. For instructions on installing and commissioning gas and fire detectors, please follow the user manual instructions supplied with the detectors. Alternatively contact Crowcon for advice.

To complete the installation of your Gasmaster system you will need to use the Operator panel and Menu. Full instructions can be found in section III. Operation, you are advised to familiarise yourself with the operator buttons on the front panel and the menu structure, see page 25. Some configuration steps may require you to enter Supervisor mode. Crowcon advises that personnel familiar with installing and commissioning gas and fire detection systems carry out this part.

If you have purchased a Gasmaster 1

Please follow the instructions in this section but ignore the reference to additional channels.

If you have purchased a non-configured Gasmaster 4

Please follow the installation instructions for a pre-configured Gasmaster 4. Additional information on setting-up your Gasmaster system can be found in section III. Operation.

Step-by-step instructions

The installation and commissioning of your Gasmaster system is presented in easy to follow instructions. A summary table of contents detailing a typical sequence of installation steps is shown below. Depending on your configuration some or part of each step may be omitted.

Note: two batteries are shipped separately from the main unit to prevent potential damage during transit. These should be installed as shown in section 2.2.

Warning: Gasmaster is not certified for use in hazardous areas, but may be connected to detectors and/or alarm devices which are installed in a hazardous area. Instructions for field devices must be closely observed when installing a Gasmaster system.

- 2.1 Before installation
- 2.2 General
- 2.3 Mounting
- 2.4 Cabling requirements
- 2.5 Installing gas and fire detectors
- 2.6 Installing output devices
- 2.7 Connecting mains power
- 2.8 Connecting input devices
 - 2.8.1 Two wire 4-20mA devices
 - 2.8.2 Three wire 4-20mA devices
 - 2.8.3 mV bridge pellistor detectors.
 - 2.8.4 Heat/smoke detectors
 - 2.8.5 Environmental Sampling Unit (ESU)
 - 2.8.6 Flame detectors
 - 2.8.7 Remote inhibit and accept/reset inputs
- 2.9 Connecting output devices
 - 2.9.1 Audible visual alarms
 - 2.9.2 Common relay connections
 - 2.9.3 Channel relay connections
 - 2.9.4 Analogue outputs
 - 2.9.5 RS485 communications
- 2.10 Applying power
- 2.11 Battery back-up time/power calculations
- 2.12 Commissioning
 - 2.12.1 Commissioning mV pellistor detectors
 - 2.12.2 Zero adjustment and calibration
 - 2.12.3 Testing fire channels
 - 2.12.4 Testing ESU channels

2.1 Before installation

Before carrying out any installation work, ensure that local regulations and site procedures are followed. Further advice is available from Crowcon if required.

Gasmaster is intended for use in non hazardous areas. Gas and fire detectors may be mounted in potentially flammable atmospheres using appropriate barrier devices where necessary. Check the equipment to be installed is suitable for the area classification. Please refer to instrument installation manuals for information on location.

Crowcon recommends the installation of Gasmaster be carried out by people with experience of installing electrical equipment in potentially hazardous areas.

2.2 General

This section describes how to get started with a *Gasmaster 4* or *Gasmaster 1* system that has been pre-configured for the detectors supplied. Figures 2.1, 2.2 and 2.5 show the internal structure of Gasmaster.

See the *Specification and Inspection Certificate* provided with your system for full details of its configuration.

Figure 2.1 shows the internal arrangement of a Gasmaster system. The front cover ① is removed by unscrewing the four screws ② and carefully disconnecting the two-pole sounder connector from the display PCB ③. The front cover can either be supported by the case using one of the retaining screws, or removed completely and placed in a safe location. Two separate chassis support the display PCB and batteries which supports the display PCB ③ and batteries ④. The terminal PCB ⑦ contains the input modules, and all of the input and output terminals. The display PCB ③ is connected to the terminal PCB ⑦ via a 50-way ribbon connector, and is hinged on the left side so that it can be moved to provide access to the detector input terminals. Most terminals are accessible once the display PCB is moved and the batteries are removed. If necessary the two chassis can be removed for easier terminal access. In order to remove the display chassis, the display PCB ribbon connector must first be carefully un-plugged. Care should be taken when re-fitting the display

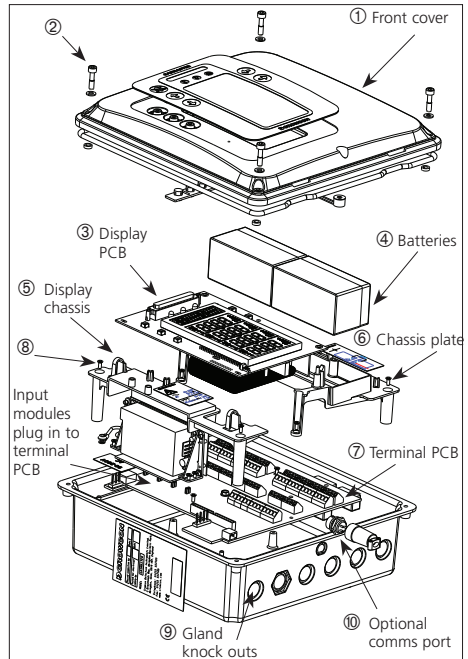

Figure 2.1 Exploded view of Gasmaster

PCB so as not to damage the connector or ribbon cable.

Six punched cable gland knock-outs are provided on the top and bottom of the enclosure. The knock-outs are suitable for M20, 1/2" NPT or PG13.5 cable glands. To remove knock-outs, tap around the edge of the recessed flange using a small hammer and a screwdriver. The knock outs should then come away from the enclosure. Knock-outs should be removed prior to mounting Gasmaster and great care must be taken to avoid damaging internal components.

Power supply

Gasmaster comes fitted with an auto-ranging power supply suitable for 100-240 V ac 50-60 Hz operation. This provides a nominal 24 V dc supply with a maximum power of 60 W. Alternatively Gasmaster can be powered from an external 24 V dc supply, a maximum 60 W supply is required.

Gasmaster must never be connected to ac and dc supplies at the same time.

The Gasmaster power supply contains no user replaceable fuses.

Short circuit protection

Each detector input is short-circuit protected. Self-resetting 'polyfuses' are fitted to the 24 V power supply which will cut power in the event of a cabling fault, and automatically reset when the fault is corrected. Detectors with a maximum consumption of 500 mA may be connected.

Circuit breaker

If the equipment is permanently connected to a mains supply then a dedicated circuit breaker must be included in the installation, to comply with EN 61010-1. The circuit breaker must be close to Gasmaster, in easy reach of the operator. It must be marked as the disconnecting device for the Gasmaster system, and the ON and OFF positions must be clearly marked.

The circuit breaker must comply with the relevant requirements of IEC60947-1 and IEC60947-3. The protective earth must not be disconnected even when the breaker is activated.

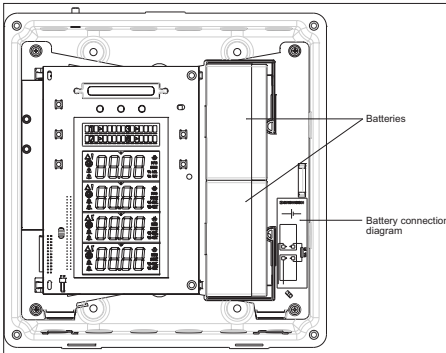

Figure 2.2 Gasmaster chassis plate with display PCB board and batteries.

2.3 Mounting

All Gasmaster systems should be installed in a safe area. Consider location, cabling and earthing requirements.

Figure 2.3 provides a dimensional view of Gasmaster. To access the mounting points, first remove the front cover by unscrewing the fixings labelled ② in figure 2.1. Carefully remove the

sounder connector from the display PCB. The cover should be placed in a secure location. It is recommended that Gasmaster is positioned by hand in the desired location, and a pencil used to mark the mounting hole positions.

Gasmaster should be removed before drilling the mounting holes.

Nylon bushes suitable for up to 5mm screws are fitted within the Gasmaster mounting points. Ensure these bushes are present when mounting as they are essential to maintain the ingress protection of the enclosure.

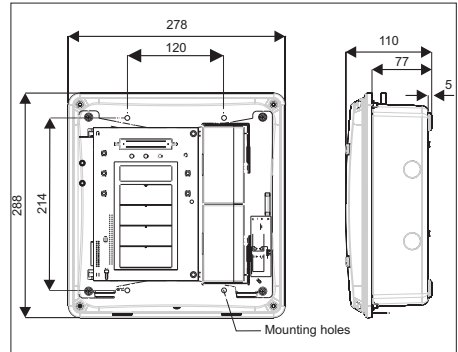

Figure 2.3 Dimensional view of Gasmaster with mounting holes shown

2.4 Cabling requirements

Cabling to Gasmaster and detectors must be in accordance with the recognised standards of the appropriate authority in the country concerned, and must meet the electrical requirements of the detector.

■ Explosion-proof (Exd) devices

Crowcon recommends the use of steel wire armoured (SWA) cable. Suitable explosion-proof glands must be used.

■ Intrinsically Safe (I.S.) devices

Crowcon recommends the use of twisted pair cable with overall screen and sheath. Suitable weatherproof glands must be used. I.S. devices must be used with a suitable Zener Barrier or Galvanic Isolator when used in a hazardous area.

■ **Fire detectors,**

Crowcon recommends the use of twisted-pair cable, screened with an overall protective sheath that is fireproof, for example, Pirelli FP200 or similar. A 1K8 end-of-line resistor must be fitted to the last detector on each conventional smoke or heat detector loop.

Alternative cabling techniques, such as steel conduit, may be acceptable provided that appropriate standards are met.

The minimum acceptable supply voltage measured at the detector and the maximum current drawn by that detector is different for each device. Please refer to the relevant Installation, Operating and Maintenance Instructions provided with each detector to calculate the maximum cable distances allowed for different cable types. The maximum cable distance allowed is dependent upon the installation, for example, whether Zener Barriers or Galvanic Isolators are required (for I.S. devices) or not.

When calculating maximum cable distances for detectors, assume a minimum supply of 19 V and a sense resistance of 98 Ω (39 Ω for conventional fire channels).

Table 1: Typical cable characteristics

c.s.a (mm ²)*	Resistance (Ω per km)	
	Cable	Loop
0.5 (20)	39.0	78.0
1.0 (17)	18.1	36.2
1.5 (15)	12.1	24.2
2.5 (13)	8.0	16.0

*Approximate c.s.a. in awg given in brackets.

Cable lengths should be calculated according to the equations defined in the detector instructions sheet and the cable and Gasmaster characteristics specified above.

There are a number of suitable ways of terminating cables and glands to Gasmaster dependant on the cable and gland type:

- Steel wire-armoured (SWA) cable and glands with electrical termination of the armour to the enclosure via the gland.

- Screened cable with the screen terminated inside the enclosure via a metal tag attached to the gland.
- Screened cable using an EMC gland where the screen is terminated to the enclosure via the gland.
- For detectors, 4-20 mA outputs and RS-485 terminations: screened cable where the screen is connected to the SCR terminal on the appropriate terminal strip.

2.5 Installing gas and fire detectors

Install gas and fire detectors as per instrument installation manuals, paying attention to location and cabling requirements. For ESU devices please refer to installation manual provided.

2.6 Installing output devices

Gasmaster can drive 12 V dc or 24 V dc audible visual alarms directly via the Audible Visual drive terminals on the terminal PCB. Relays are provided for switching additional outputs, and 12 V dc or 24 V dc 200 mA auxiliary supplies are available adjacent to each block of relay terminals for switching low power devices. Section 2.9 provides detailed information on connections to output devices.

2.7 Connecting mains power

Connect the external power supply using the two part screw terminals, refer to Figures 2.4 and 2.5. Gasmaster must be earthed either at the power connector earth terminal (see Figure 2.4) or using the stud on top of the enclosure.

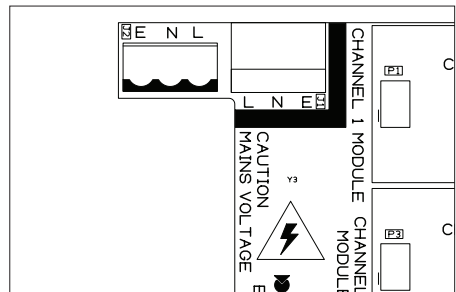

Figure 2.4 Mains connection terminals on terminal PCB

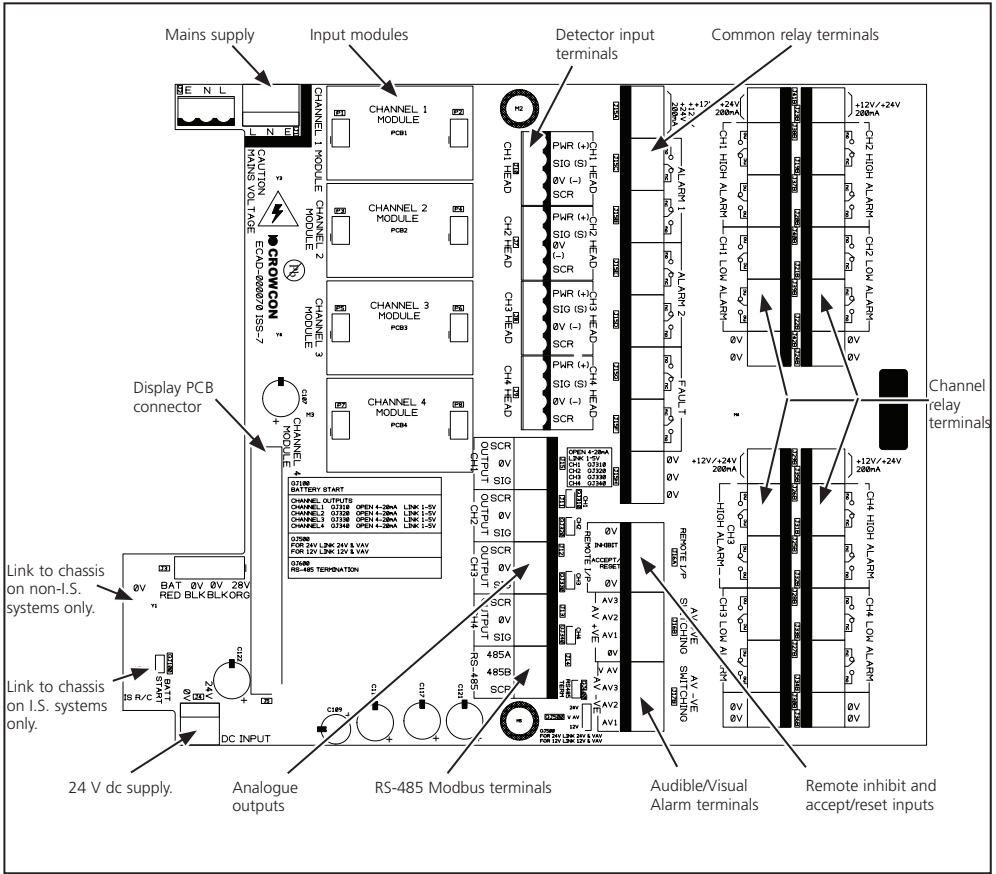

Figure 2.5 Terminal PCB layout

2.8 Connecting input devices

Gasmaster may be fitted with between one and four input modules (one only for Gasmaster 1) of the following types:

- 4-20mA/Fire module for 4-20mA type detectors, conventional smoke/heat detectors or ESU.
- mV Pellistor module for mV bridge type flammable gas detectors.

Details of hardware configurations and link settings can be found in section 2.8.1 to 2.8.6.

4-20 mA Inputs

Gasmaster provides analogue 4-20 mA inputs with a sensor supply voltage of 19 to 28 V dc and measures the signal across a 98 Ω sense resistor. Inputs can be gas detectors or flame detectors in 4-20 mA 2-wire sink, or 3-wire sink or source configurations. Gasmaster will track inputs from 3 to 21.5 mA at which point an 'over-range' fault will be indicated. Connection details are shown in section 2.8.1 and 2.8.2.

Conventional fire detectors

A loop of up to 20 conventional smoke/heat detectors (for example Apollo Series 65 or Orbis

devices') can be connected to each Gasmaster input channel. A fire loop can also comprise switched devices such as manual alarm call points or flame detectors, and devices can be mixed on the same loop provided electrical characteristics are compatible and fire regulations allow. Switched devices require a 470 Ω series resistor. Each fire loop must be terminated with a 1K8 end-of-line resistor, which is monitored to provide indication of open circuit or short circuit faults. Connection details are shown in section 2.8.3.

Environmental Sampling Unit (ESU)

Each Gasmaster input can monitor a Crowcon Environmental Sampling Unit (ESU), which enables detection of flammable or toxic gases over a wide area using a sample draw technique. It is essential that the sampling device on the ESU is operating correctly, and Gasmaster provides this monitoring function to ensure a sample is being drawn. Gasmaster provides a 2-wire 24 V dc supply to the sampling device. Separate Gasmaster input channels are required to monitor the gas detector or detectors fitted to the ESU. Connection details are shown in section 2.8.5.

mV bridge pellistor detectors

Some flammable gas detectors provide a mV bridge type signal rather than a 4-20mA signal. Example Crowcon products are Xgard Type 3 and Xgard Type 4. The procedure for setting-up these detectors is different from 4-20mA devices: refer to section 2.12.1 for detailed instructions on commissioning mV bridge type detectors

Please contact Crowcon for specific wiring details for Crowcon detectors

2.8.1. Two wire 4-20mA devices

Figure 2.6 shows a typical wiring configuration for a 2-wire current sink detector for safe area use only.

Figures 2.7 and 2.8 show typical wiring configurations for I.S. detectors installed in hazardous areas using Zener Barriers or Galvanic isolators. Refer also to section 1.3.

Set the link on the 4-20 mA/Fire input module to *SINK* in all cases.

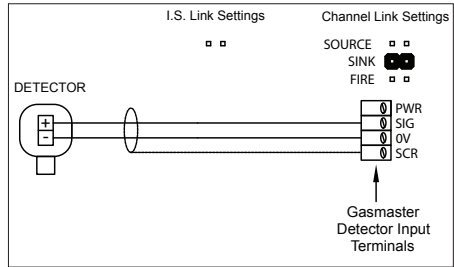

Figure 2.6 Connections for 2 wire detector 4-20mA/Fire input module

Figures 2.7 and 2.8 show typical wiring configurations for a 2 wire sink I.S. detector with Zener barrier or Galvanic Isolator. Set the link for the appropriate channel as shown in each diagram.

2.8.2. Three wire 4-20mA devices

Figure 2.9 shows a typical wiring configuration for a 3-wire detector. Set the link on the 4-20 mA/Fire input module to *SOURCE* for a current source detector, and *SINK* for a detector configured as current sink.

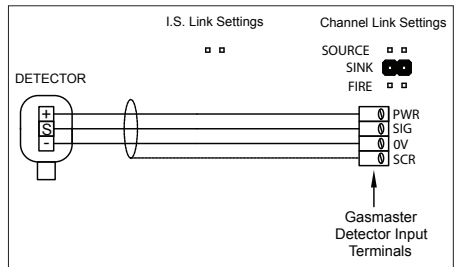

Figure 2.9 Connections for 3 wire detector 4-20mA/Fire input module

2.8.3. mV bridge pellistor detectors.

Detectors such as Crowcon's Xgard Type 3 or 4 should be connected as shown. Refer to section 2.12.1 for instructions on detector set-up.

Refer to Figure 5.1 on page 37 for wiring details.

Warning: Ensure the 'Head Voltage' potentiometer is set fully anti-clockwise before connecting and powering mV pellistor type detectors for the first time (or when fitting a new/replacement mV module). This will ensure the voltage supplied to

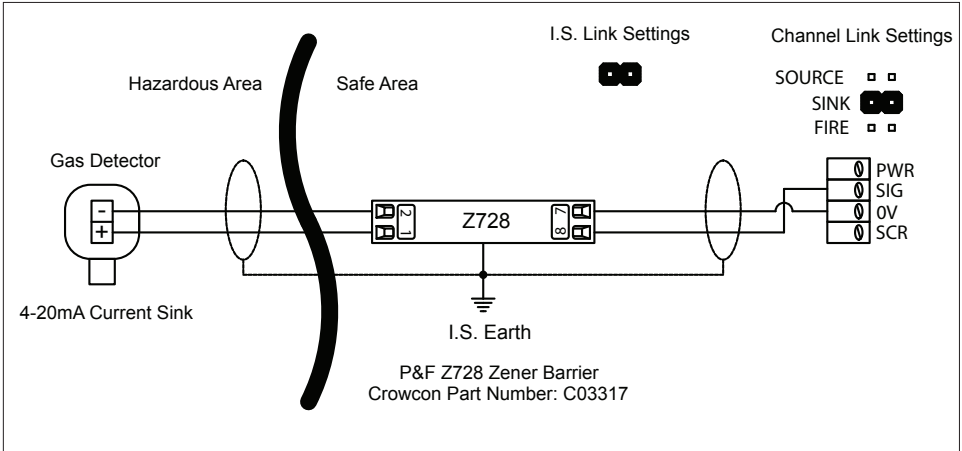

Figure 2.7 Typical connections for 2 wire I.S. detector with Zener barrier, 4-20mA/Fire input module Set channel link to SINK (see figure 2.5) and configuration to DET4-20 SINK (see Menu System Overview section, page 25 and 33. Refer to earth connection requirements on Figure 2.5, page 7

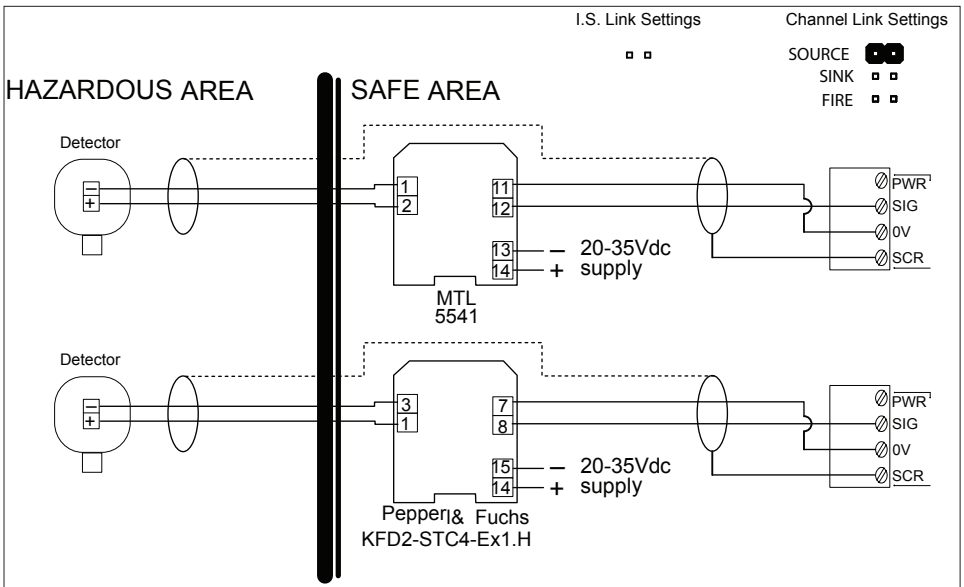

Figure 2.8 Typical connections for 2 wire I.S. detector with Galvanic Isolator, 4-20mA/Fire input module. Set channel link to SRCE (see figure 2.5) and configuration to DET4-20 SRCE (see Menu System Overview section, page 25 and 33.

the sensor is set to minimum and avoid potentially burning-out the pellistor by applying excessive voltage.

2.8.4. Heat/smoke detectors

Conventional fire detectors for safe area use should be setup according to Figures 2.10 and 2.11. Conventional fire detectors for hazardous area use should be setup according to Figure 2.12.

Figure 2.11 shows connections for manual alarm call points.

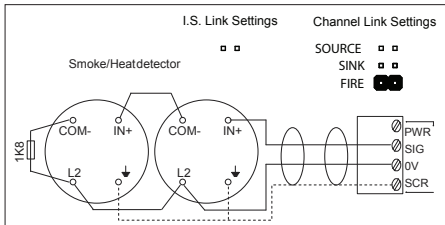

Figure 2.10 Connections for smoke/heat detector, 4-20mA/Fire input module

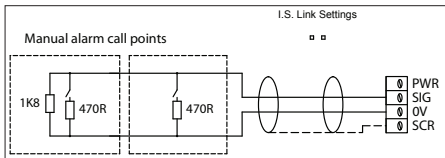

Figure 2.11 Connections for manual alarm call points, 4-20mA/Fire input module

2.8.5. Environmental Sampling Unit (ESU)

Figure 2.13 shows the wiring configuration for monitoring the ESU sampling device. Gas detectors fitted to the ESU should be cabled separately to the appropriate input channels on the Gasmaster or other control panel. For connections, details are shown on the instructions provided with the ESU.

Figure 2.13 shows the wiring configuration for monitoring the ESU sampling device. Gas detectors fitted to the ESU should be cabled separately to the appropriate input channels on the Gasmaster or other control panel. For connections, details are shown on the instructions provided with the ESU.

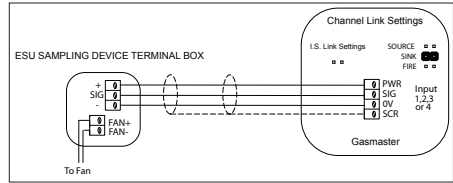

Figure 2.13 Connections for ESU sampling device, 4-20mA/Fire input module

2.8.6. Flame detectors

Figure 2.14 shows a typical wiring configuration for a 4-20 mA 3 wire Flame detector. Set the detector type link appropriate for the type of flame detector, refer to Figure 2.5. **Do not set link to FIRE.**

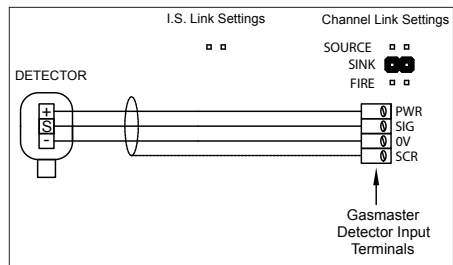

Figure 2.14 Connections for 4-20 mA 3 wire Flame detector, 4-20mA/Fire input module

2.8.7. Remote inhibit and accept/reset inputs

Gasmaster has inputs for the connection of remote switches to inhibit alarm outputs or accept and reset alarms. Inputs are activated when pulled down to 0 V, the open circuit voltage is 5 V dc.

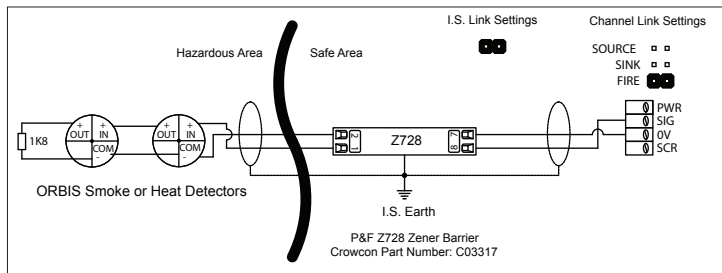

Figure 2.12 Connections for conventional fire detectors for hazardous area, 4-20mA/Fire input module
Refer to earth connection requirements on Figure 2.5, page 7

Warning
 Crowcon strongly recommends that remote inhibit switches be key operated only, and that access to the key should be restricted to authorised personnel. A Gasmaster system that has been inhibited without other safety precautions being in place may not provide the protection for which it was designed. Steps should be taken to ensure that all appropriate personnel are aware when a Gasmaster system is inhibited.

Remote ACCEPT/RESET

Close the contact momentarily to accept alarms and cancel audible alarms. Close the contact again when the hazard is cleared to reset alarms.

Remote INHIBIT

Closing the contact will inhibit alarms on all input channels. Channels will remain inhibited until the contact is opened; the Gasmaster will then return to its original state (any channels that have been set to inhibit using the Supervisor menu will remain inhibited). Figure 2.15 shows wiring configurations for remote inputs.

Crowcon recommends screened cables for connecting remote switches. The screen should be terminated at the appropriate 'SCR' terminal.

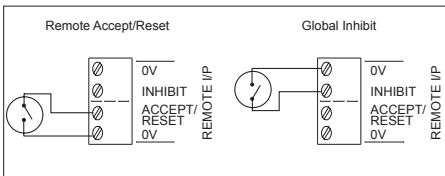

Figure 2.15 Connections for remote inhibit/accept/reset inputs

2.9 Connecting output devices

WARNING: After accounting for internal power consumption, the maximum power available for input and output devices is 48 W

2.9.1. Audible visual alarms

Figure 2.16 shows a typical wiring diagram for audible & visual (A/V) alarms, in this example a two-tone sounder is depicted. The A/V drive from Gasmaster is capable of providing up to 650mA, which equates to two general purpose A/V alarm

devices using xenon type beacons. A greater number of LED-based beacons may be powered; contact Crowcon for advice.

Gasmaster is compatible with 12 V dc or 24 V dc A/V alarms (Gasmaster can be set for 12v or 24V output; not both): refer to Figure 2.16 for link settings.

Gasmaster is compatible with A/V alarms which require a common 0V supply (+VE switched), or a common +VE DC supply (0V or '-VE' switched). Connect the A/V device to the 'AV +VE SWITCHING' or 'AV -VE SWITCHING' terminals as appropriate.

Two separate sounder outputs are provided to activate on level 1 and level 2 alarms respectively (terminal AV2 becomes active on alarm level 1; AV3 becomes active on alarm level 2). If a single tone sounder is used, connections should be to terminal AV2 (and the common terminal) only. The sounder will activate on alarm level 1.

Terminal AV1 is intended to drive a visual alarm and activates on a level 1 alarm.

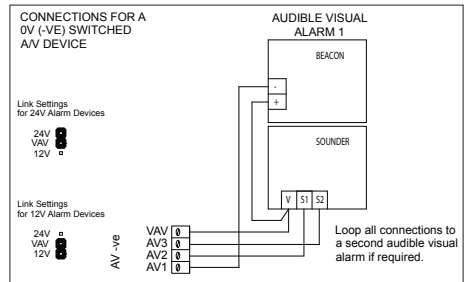

Figure 2.16 Connections for AV drive

2.9.2. Common relay connections

Double-Pole-Change-Over (DPCO) relays with contact rating of 250 V ac @ 8 A (non-inductive), 5 A (inductive) are provided for Alarm 1, Alarm 2 and Fault. Each relay can be set in its non-active state as energised (*Fail safe*) or de-energised. It is common practice to set the Fault relay as *Fail Safe* so in the event of power loss, the fault relay will change state. See Figure 2.5 for Common Relay terminal location and Figure 2.17 for contact definitions. Terminals are fitted adjacent to all relay blocks to provide 12 V or 24 V dc supplies for switching low power devices. The dc auxiliary

output terminals may be set to either 12 V dc or 24 V dc by moving the 'V AV' link. Refer to Figure 2.5 on page 7 for details

Common Alarm and Fault relay configurations can be set using the User Control Panel and Menu System. See Section 3 "Operation" on page 17 for details.

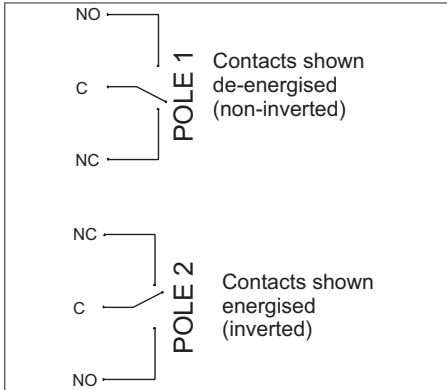

Figure 2.17 Gasmaster contacts for all relays are identified on the terminal PCB.

2.9.3. Channel relay connections

Gasmaster 4 provides Double-Pole-Change-Over (DPCO) relays for each channel. The relays provide a contact rating of 250 V ac 8 A (non-inductive), 5 A (inductive) for Alarm 1 and Alarm 2. Each relay can be set in its non-active state as energised (*Fail safe*) or de-energised. Refer to Figure 2.5 for location of Channel Relay terminals and Figure 2.17 for contact definitions. Terminals are fitted adjacent to all relay blocks to provide 12 V or 24 V dc supplies for switching low power devices. The dc auxiliary output terminals may be set to either 12 V dc or 24 V dc by moving the 'V AV' link. Refer to Figure 2.5 on page 7 for details

Channel Alarm thresholds and configurations can be set using the User Control Panel and Menu System. See Section "3. Operation" on page 17 for details.

Fire Channels

Conventional fire channels will activate both Alarm 1 and Alarm 2 relays on the affected channel in the event of an alarm. The Common Alarm 2 relay will also activate (the Common Alarm 1 relay will

not activate). 4-20 mA flame detectors will activate two levels of alarm as per a gas detector.

The Channel Alarm 1 relay will operate as 'non-latching'; this is not configurable. The Channel Alarm 2 and Common Alarm 2 relays can be configured as 'latching', 'non-latching' or 'latching acceptable'.

ESU Channels

If the ESU sampling device slows significantly causing reduced sample flow the Alarm 1 relay for that channel will activate. If the sampling device stops the Alarm 2 relay will activate. The Common Alarm relays **will not** activate if the sampling device slows or stops. If the cable to the sampling device is open or short-circuited the Common Fault relay will activate.

2.9.4. Analogue outputs

Gasmaster provides an analogue output for each channel which can be set as either 4-20 mA or 1-5 V dc by fitting a link (see Figure 2.18). These signals can be used to drive PLC/DCS/SCADA systems or remote displays. 4-20 mA outputs are current source (resolution 0.1 mA) and can drive a maximum load of 700 Ω, 1-5 V outputs require a minimum load of 50 KΩ.

Analogue outputs will function in the following way:

4-20 mA gas detectors: the output will track the input from 3 to 21.5 mA, the signal will drop to 0 mA if the input rises above 21.5 mA to signal a fault. A sensor signal that is greater than 110% of range is designated by Gasmaster as a fault condition. The signal will be set to 2 mA to indicate when a channel is inhibited, and 0 mA when a channel is in fault.

Fire channels: a signal of between 4 and 12 mA indicates a 'no-fire' condition, 12-20 mA indicates a fire, 0mA indicates a fault (open or short circuit). A 2 mA signal indicates that a channel is inhibited.

ESU channels: a signal of between 4 and 12 mA indicates the sampling device is operating correctly, 12-20 mA indicates a sampling device failure, 0 mA indicates a fault (open or short circuit). A 2 mA signal indicates that a channel is inhibited.

mV Pellistor channels: the output will rise between 4mA and 19.2mA according to the 0-95%LEL

input signal. If the 'pellistor saver' function is enabled, at 95%LEL (this value is adjustable) gas concentration the channel will enter 'pellistor saver' mode (refer to section 3.9); the channel will go into fault and the analogue output signal will be set to 0mA.

If the 'pellistor saver' function is disabled the analogue output will rise to a maximum of 25.8mA; the %LEL indication will depend on the gain levels set for the sensor.

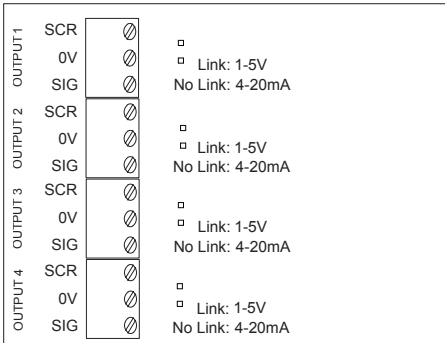

Figure 2.18 Gasmaster analogue output connection terminals

2.9.5. RS-485 communications

Gasmaster can provide alarm and system information to PLC/DCS/SCADA systems via a two-wire link using the Modbus RTU protocol (9600 baud, 8 data bits, no parity, 1 or 2 stop bits). Up to 16 Gasmaster systems can be 'multi-dropped' on a single two-wire link with a maximum cable length of 1 Km, two-core twisted pair cable is recommended. Single Gasmaster systems that are to communicate via the RS-485 link should have the *RS485 TERM* link made, which connects a terminating resistor. For multi-dropped systems the *RS485 TERM* link should be removed from all Gasmasters except the last unit on the line.

A Modbus specification document is available from Crowcon on request.

The RS-485 terminals on Gasmaster systems ordered with the optional local communications connector will be used for terminating the connector leads. These leads must be removed if a remote RS-485 serial link is required.

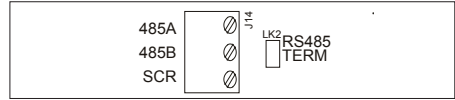

Figure 2.19 Gasmaster RS-485 terminals

2.10 Applying power

Before applying power ensure that any control or shutdown systems to which the Gasmaster is connected are inhibited.

Once all field cables have been installed, the batteries can be connected as per the diagram attached to the chassis plate. (Refer to section 4.4.) Gasmaster will not power up until an external power supply is applied.

Apply power to Gasmaster from either the AC or 24 V dc external supplies. Outputs are inhibited for a preset time after power-up, and the system will perform a start up sequence testing alarm indicators and the internal sounder. If after a settling period faults are reported, check the sensor connections again or refer to "Faults menu (lists faults present on the system)" on page 24.

When power is applied the green Power LED will illuminate and flash every 5 seconds to indicate that the system is operational.

If the external supply fails, Gasmaster will continue to operate from its internal batteries and the Power LED will flash every second. Depending on configuration, Gasmaster will display either a Warning (Warning LED lights and the sounder will beep every 5 seconds) or a fault (the Fault LED and sounder will activate, and the fault relay will change state).

Gasmaster should display all channels being monitored. Allow sensors to settle before commencing calibration, refer to sensor instructions supplied with detectors for recommended settling times.

Note: your Gasmaster is supplied pre-configured, refer to the *Specification and Inspection Certificate* provided with your system. If no channels are configured, Gasmaster will display the following screen:

No detectors!
Please configure

To configure your system go to page 25.

2.11 Battery back-up times

Gasmaster is fitted with 1.2 Ah batteries to provide continued operation in the event of a power loss. Examples of typical back-up times are provided below for a system in a non-alarm state, relays set as de-energised and with the 4-20mA outputs unused (system current consumption without detectors is approximately 50mA):

- Gasmaster 1
 - with a toxic gas detector (2-wire): 21 hours
- Gasmaster 1
 - with an oxygen detector (2-wire): 16 hours
- Gasmaster 1
 - with a mV pellistor flammable gas detector: 12 hours
- Gasmaster 4
 - with four toxic gas detectors (2-wire): 10 hours
- Gasmaster 4
 - with four oxygen detectors (2-wire): 4 hours
- Gasmaster 4
 - with four mV pellistor flammable gas detectors: 3 hours

Gasmaster incorporates protection to prevent the internal batteries being damaged by being deeply discharged. When operating from internal batteries, Gasmaster will display a "Warning - battery low" fault message when the battery voltage drops to 22 V. When the voltage drops to approximately 20 V, the batteries will be automatically disconnected. The batteries will only be re-connected when the external power supply is re-instated, and will take approximately 18 hours to fully re-charge.

Note: The internal batteries may not be charged efficiently when Gasmaster is powered from an external dc supply, and therefore the back-up function may not work if the external supply fails

Please contact Crowcon for further advice.

2.12 Commissioning

Note: it is strongly recommended that persons intending to commission a Gasmaster system first read and understand the Operating instructions provided in section III. Operation.

When all field devices have been connected and powered-up, commissioning can commence. Gas detectors should be calibrated according to their instructions, fire detectors should be tested using appropriate tools.

Alarms should be simulated and actions noted to ensure that the system operates as intended. All warning devices should be checked, and interfaces with auxiliary equipment should also be verified. The Test and View menu's are provided for this purpose (see page 30 and on page 27).

2.12.1. Commissioning mV pellistor detectors

It is essential for these types of detectors that the correct 'head voltage' and balance is set before attempting to zero and calibrate the sensor.

To set the head voltage, measure the voltage across the '+' and '-' terminals at the detector and adjust the 'HEAD VOLTAGE' potentiometer on the appropriate Gasmaster input module. Check the detector instructions for voltage settings: 2 V dc is typical for an Xgard Type 3 or 4 detector.

Allow the sensor to warm-up for 1 hour and then adjust the amplifier balance as follows: connect a meter set in the dc mV range to test-points TP12 and TP13 on the Gasmaster mV pellistor input module. Adjust the 'BALANCE' potentiometer until the meter reads '300 mV'.

The sensor is now ready for zeroing (having first checked no flammable gas is present) and calibration.

Note: for some gas types or pellistor types it may be necessary to change amplifier gain settings. These procedures are explained on technical note FGM3-001 which can be downloaded from the Partners section of the Crowcon website. Alternatively contact customersupport@crowcon.com.





2.12.2. Zero adjustment and calibration



Calibration must be carried out separately on individual gas detectors on Gasmaster. Follow calibration instructions supplied with each detector. Ensure at all times the local legislation and codes of practice are complied with.





Allow detectors to stabilise for at least one hour before commencing calibration. Refer to detector manual for more information.



Gasmaster provides Zero and Calibration Wizards to enable you to carry out calibration easily. These are accessed through the Operator Display Panel and Menu System. Section III. Operation provides detailed information on the menu structure and operator buttons.

Zero adjustment

1. From the normal operating display, press the **Continue**  button to enter the menu system.
2. Use the **Up**  and **Down**  buttons as necessary to select **Supervisor** and press **Continue** .
3. You will be asked to enter a *password*, press **Continue** .

The default password is ZZZ (uppercase), use the **Up**  and **Down**  buttons to enter the first character of the password.







Note: Double click the **Up**  or **Down**  button to move to the top or bottom of the alphabet list. To enter numbers or lower case characters, continue pressing the **Up**  or **Down**  button.

When you have selected the correct character, press **Continue** , the cursor will move to the next character position. Continue entering the rest of the password. When you have finished press the **Continue**  button twice.

(See 3.7 in section III. Operation for details of entering text strings).





4. The Zero Wizard offers temporary Inhibit but you may wish to Inhibit all channels during the calibration process.

How to set global inhibit:

From the **Supervisor** menu, scroll down to **Inhibit** and press **Continue** . Select **All** and press **Continue** . Use the **Up**  or **Down**  button to set inhibit to **INHIBIT=ON**, press **Continue**  to accept. Use the **Back**  button to return to the **Supervisor** menu. The Inhibit icons will appear on the channel display.



How to set channel inhibit:

Channel inhibit can be selected from the **Inhibit** menu or within the **Zero** or **Calibrate** menu. Follow the instructions provided above, selecting the **Channel #n** (where n represents the channel number) in place of **All**.

5. From the **Supervisor** menu, use the **Up**  and **Down**  buttons to select **Zero** by pressing the **Continue**  button.
6. Select the channel to apply zero. Press the **Continue**  button to step through the Zero Wizard.
7. Press **Continue**  when `'..Only continue if in clean air!..'` is displayed, ensure the detector has been correctly zeroed first (i.e. 4 mA)

Press **Continue**  to apply **Zero now**.

Gasmaster will display 'Pass' when zero is successful or 'Fail' if the detector zero is out of range.

8. Use the **Continue**  button to Zero other channels or **Back**  button to the **Supervisor** menu to continue calibration.

Calibration

1. Follow points 1 to 3 above in Zero adjustment to enter **Supervisor** mode.
2. Before you commence calibration, ensure the channels are inhibited prior to applying gas. Channels can be inhibited globally or individually.

Follow the instructions given in step 4 in Zero Adjustment.

3. From **Supervisor** menu, scroll down and select **Calibrate**.
4. Select the channel to calibrate. Press the **Continue**  button to step through the

Calibrate Wizard. Ensure the channels are inhibited prior to applying gas.

5. The next wizard screen displays the default calibration gas concentration as 50% of range. If necessary this calibration figure must be adjusted to match the concentration of the calibration gas used. Adjust the value using the **Up** ⬆️ and **Down** ⬇️ buttons as necessary and press **Continue** ⬆️.
6. When "Apply Gas" is displayed, apply gas to the detector and press **Continue** ⬆️, allow readings to settle.
7. Press **Continue** ⬆️ when the reading on the appropriate channel is stable, and the detector has been calibrated according to its instructions.

Gasmaster will display 'Pass' when successful or 'Fail' if the detector signal is out of range.

8. Calibration is complete when 'Purge' is displayed, remove the gas from the detector.

Use the **Continue** ⬆️ button to calibrate another channel or **Back** ⬅️ button to exit **Supervisor** mode and return to the main display.

9. Ensure that all channel inhibits are removed after calibration is complete.

2.12.3. Testing fire channels

To test **smoke detectors**, inhibit the relevant FIRE channel and use a smoke test aerosol to test each detector on a loop in turn. The channel display will indicate FirE when the detector activates. Each detector on a loop should be reset before testing the next to ensure that all detectors activate the alarm.

Heat detectors can be tested with a heat-gun using the same method as described above.

Flame detectors can either provide a signal using contacts, or a 4-20 mA signal.

A contact type detector will be connected as a conventional fire loop using 470 Ω series resistors and a 1K8 end of line resistor and will only indicate FIRE or FAULT. A 4-20 mA detector will be

connected directly as a 4-20 input, and may have various alarm levels to indicate UV or IR activation (please refer to the instructions supplied with the device for details). Flame detectors require a UV or IR torch (depending on detector type) to simulate alarms. Inhibit the relevant channel, shine the torch at the detector and check that FirE is shown on the Gasmaster display. For 4-20 mA detectors, also check that the appropriate alarm level is displayed.

2.12.4. Testing ESU channels

To test a channel monitoring an ESU sampling device, inhibit the channel and manually slow the device, check that Alarm Level 1 is activated. Manually stop the device and check that Alarm Level 2 is activated. If the alarms do not activate the thresholds may need changing, refer to section 3.10 for details on how to change alarm levels.

When commissioning is complete ensure that the system is left fully functional with no faults present and no channels inhibited.

3. Operation

Every Gasmaster system is pre-configured by Crowcon, please refer to the *Specification and Inspection Certificate* provided with the product for configuration details. This section describes the operation of pre-configured units, and includes procedures for altering settings.

3.1 Gasmaster Operator Panel

The Operator Panel allows you to communicate with Gasmaster. Use it to monitor the status of all attached field devices, determine system settings and configuration of field devices. Figure 3.1 shows the Operator Panel and typical display under normal, non-alarm monitoring conditions.

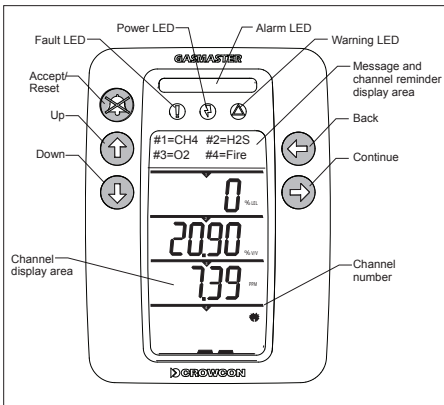

Figure 3.1 Operator Display Panel and buttons

Gasmaster Display

The User display provides continuous readings for up to 4 field devices plus a display area for user messages and channel number summary. Gasmaster 1 provides display for one field device plus the message area.

Message display area

In normal, non-alarm condition, the message area displays the channel numbers and detector types, e.g. CH4 refers to methane detector, see following example.

The # symbol represents the channel number (i.e. #1 is channel 1).

#1=CH4	#2=O2
#3=H2S	#4=Fire

In the event of an alarm, this message area will display the channels in alarm and their location. See section 3.8 for more information on alarm conditions.

ALARM:	#1=CH4
Boiler room	

If more than one channel is in alarm, the alarm message will cycle through all messages.

In the case of a fault (or warning), brief details of the fault will be displayed. See section 3.9 for more information on fault conditions. Detailed fault and warning messages can be found in section 3.10.

FAULT:	=30
Chan #3 over range..	

Note: User messages longer than sixteen characters are displayed as scrolling text.

If fault and alarm conditions are present at the same time, alarm messages take priority.

Channel display area

Gasmaster 4 has a large clear display which shows all gas levels simultaneously. Gasmaster 1 has a display for one gas level only, see figure 3.2. The image below shows details of the channel display area and icons that are used on Gasmaster.

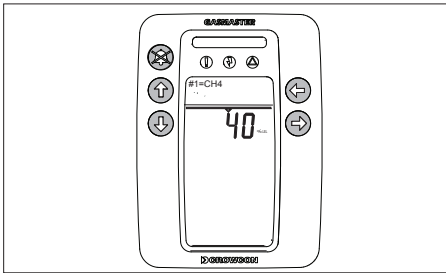
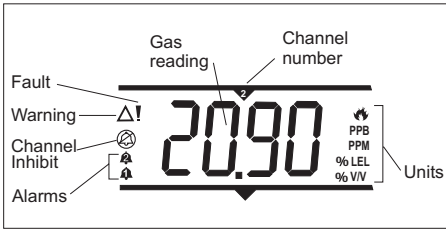

Figure 3.2 User display Gasmaster 1

Display panel LEDs

The LEDs on the Gasmaster Display Panel indicate the following:

Yellow Fault LED:

Lights when any detector or system fault is detected (see page 24 for a list of fault messages). The fault LED operates with the common fault relay, and can be set as latched or non-latched dependant on the system configuration.

Yellow Warning LED:

Lights when a warning condition is present (see page 26 for a list of warning messages). The warning LED will automatically reset when the cause is cleared.

Green Power LED:

Is normally on when power is present, and will switch off briefly once every five seconds to indicate that the system is operational. The LED will flash on and off every second when Gasmaster is operating from its batteries due to power failure.

Red Alarm Bar:

Will flash when an alarm from any channel is

triggered, and will remain in a steady 'on' state when the accept/reset button is pressed. The LED bar will flash again if a new alarm is triggered.

Operator Panel Buttons

Use the five operator buttons to respond to alarm conditions, examine the status of system settings, and configure Gasmaster.



ACCEPT/RESET

Press the **Accept/Reset** button to mute the internal sounder and external alarms. When alarm or fault conditions have cleared, press **Accept/Reset** again to reset the system.

Double-click the **Accept/Reset** button to exit the menu system and return to message display.



UP and DOWN

Use the **Up** and **Down** buttons to scroll through menu items.



Press and hold the **Up** or **Down** button to move quickly through the menu items.

Double-click the **Up** or **Down** button to move directly to the top or bottom of the alpha-numeric characters when configuring text or entering the Supervisor password

In **Supervisor** Mode (see section 3.7), use the **Up** and **Down** buttons to change values or settings.

In normal, non-alarm conditions, press and hold the **Up** and **Down** buttons to adjust the message display area brightness.



CONTINUE

Use the **Continue** button to display available menus. The menu system can be accessed during normal channel monitoring, alarm or fault condition. Gasmaster has four standard menus plus one advanced menu. See figure 3.5 on page 25 for an overview of Gasmaster's Menu System. The standard and advanced menus are as follows:

- **Faults**
Lists the fault conditions present
- **Warnings**
Lists the warning conditions present
- **View**
View current status of relays, outputs, detector inputs, power supply and configuration
- **Action**
Perform routine operations: tests of control panel or audio visual alarms
- **Supervisor**
Perform password protected supervisor functions: inhibit channels, calibration, testing and configuration

Use the **Continue** button and the **Up** and **Down** buttons, to navigate through the menu system. Use the **Continue** button to select and action menu items, submenus and wizard menus.

During editing and configuration of Gasmaster, use the **Continue** button to accept changes made to settings.



BACK

Use the **Back** button to exit the menu system or cancel actions. Double-click the **Back** button to cancel text edits or return to the main menu.

3.2 Gasmaster start up sequence

At power up during Gasmaster installation, or when Gasmaster is restarted, Gasmaster will initialise the system by performing a self-test. The start up sequence is shown below:

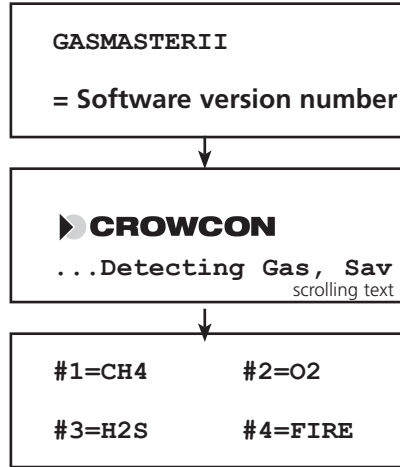
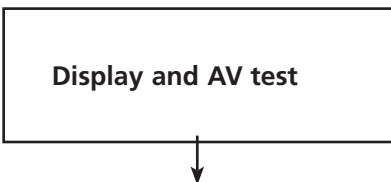

3.3 How to adjust display contrast

To edit the display contrast press and hold the **Up** ⬆ button to increase contrast, and **Down** ⬇ button to decrease contrast. The contrast level will be displayed.

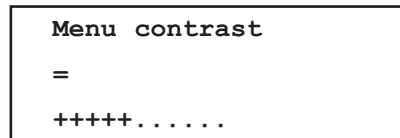

The menu display contrast is altered independently from the channel display area. Press the **Continue** ⬆ button whilst still in the Menu Contrast screen, use the **Up** ⬆ or **Down** ⬇ button to choose Menu Display or Channel Display. Press **Continue** ⬆ to select. Adjust the display contrast as described above. Press the **Back** ⬆ button to finish.

3.4 How to display Instrument serial number and system identity

The system identity and instrument serial number can be displayed during normal channel monitoring, alarm or fault conditions.

To display the system identity and instrument serial number, press and hold the **Back** ⬆ button.

First the Local Service telephone number is displayed followed by the customer identity display. After 10 seconds the serial number will automatically be displayed on the next screen (for approximately 4 seconds).

The **Continue** (⏪) button can be used to advance to the next screen. Use the **Back** (⏩) button to return to the previous screen. The display will return to the normal operating display when finished.

3.5 Using the menu system

To enter the menu system press the **Continue** (⏪) button. The menu system can be accessed during normal channel monitoring, alarm or fault condition. The message area will display the following screen:



Note: if the menu system has been accessed previously, the menu item displayed will be the last actioned menu item. For example, if you were using Supervisor mode the last time, the menu display will show this:

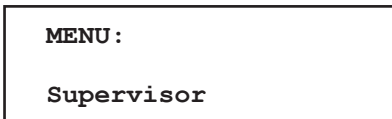

Use the **Up** (⬆) and **Down** (⬇) buttons to scroll through the menu list. To exit the menu press and hold the **Accept/Reset** button or press **Back** (⏩) button as many times as necessary.

Menu display

The top line of the message area displays the current menu level. Some menu levels have submenus and wizards that guide you through configuration. The lower line displays the menu item, value or setting.

Use the **Up** (⬆) and **Down** (⬇) buttons to scroll through the menu list, press **Continue** (⏪) to select the menu item.

Refer to figure 3.5 on page 25 for an overview of the menu system.

Menu wizards

Wizards are an extension of the menu system to guide the user through a process such as calibration. A wizard menu will consist of selections, user prompts and display status conditions during the process.

The **Back** (⏩) button can be used to return to the previous screen or abort the wizard. The **Down** (⬇) and **Up** (⬆) buttons are used to alter a selection. The **Continue** (⏪) button accepts the current selection and continues to the next step of the wizard.

Wizards are available for *Zero* and *Calibration* menus in **Supervisor** menu.

3.6 Inhibiting channels

Inputs can be temporarily inhibited so as not to cause alarms. This may be necessary when calibrating detectors, or when operations are carried out close to a sensor which may trigger an alarm (for example, soldering near a smoke detector). Input channels can be inhibited individually or all at once. The 'inhibit' option is available in the Supervisor Menu, see the Menu System Overview on page 25 for details on how to access this function.

When inhibited Gasmaster will:

- Display the 'inhibit' symbol (⊘) on the channel display for each affected channel.
- Illuminate the yellow 'Warning' LED.

In the event of an alarm on an inhibited channel, Gasmaster will:

- Illuminate the Alarm symbol (⚠) on the channel display for the affected channel.
- Illuminate the red alarm LED bar.
- Display the alarm text message for the affected channel.

Gasmaster **will not:**

- Operate any relays associated with the affected channel.
- Drive external audible visual alarms.
- Activate the internal sounder.

If it is necessary to permanently disable a channel, enter Supervisor Mode and set the relevant detector Type to Unused (see section 3.10 on page

23). The channel display will then blank, and the power supply will be removed from the detector.

Warning

Crowcon strongly recommends that remote inhibit switches be key operated only, and that access to the key should be restricted to authorised personnel. A Gasmaster system that has been inhibited without other safety precautions being in place may not provide the protection for which it was designed. Steps should be taken to ensure that all appropriate personnel are aware when a Gasmaster system is inhibited.

3.7 Using the Control Panel in Supervisor Mode

Supervisor mode provides all the functions required for trained personnel to perform system installation and configuration of field devices. This area is a password protected to prevent mis-use or accidental changes.

From the operator panel, you can select menu items and associated values to configure relays and field devices. All the menu items are explained in section 3.10 on page 23.

You can modify settings by:

- Selecting values from a list
- Editing numeric values
- Editing text strings

How to enter Supervisor mode

1. Press the **Continue** (⏪) button to enter the menu system.
2. Use the **Up** (⬆) and **Down** (⬇) buttons as necessary to select **Supervisor** and press **Continue** (⏪).
3. You will be asked to enter a password, press **Continue** (⏪). Use the **Up** (⬆) and **Down** (⬇) buttons to enter the first character of the password. The default password is ZZZ.

Note: Double click the **Up** (⬆) or **Down** (⬇) button to move to the top or bottom of the alphabet list. To enter numbers or lower case characters, continue pressing the **Up** (⬆) or **Down** (⬇) button.

For convenience, after the first character has been entered, the next character will start from the same point in the alpha-numeric list. To enter 'ZZZ' use the **Up** (⬆) and **Down** (⬇) buttons to enter the first letter, then simply press **Down** then **Continue**, **Down** then **Continue**.

When you have selected the correct character, press **Continue** (⏪), the cursor will move to the next character position. Continue entering the rest of the password. When you have finished press the **Continue** (⏪) button twice.

Note: When the Supervisor mode is active the Warning LED on the control panel will illuminate

How to select values from a list

1. With the menu item selected use the **Up** (⬆) and **Down** (⬇) buttons to scroll through the available list items. When the value you require is displayed press the **Continue** (⏪) button.

For example, when configuring the Units of a channel, the possible settings are: none, FIRE, PPB, PPM, %LEL and %VOL, as you scroll through the list the unit symbol will appear on the display.

Press **Continue** (⏪) to make a selection.

The menu screen will return to the next menu item in the list.

How to edit values of parameters

1. With the menu item selected press the **Continue** (⏪) button. Use the **Up** (⬆) and **Down** buttons to change the parameter value. Press **Continue** (⏪) to accept new value.

The menu screen will return to the next menu item in the list.

How to edit text string values

1. With the menu item selected press the **Continue** (⏪) button. A flashing cursor will appear below the first character of the text string, you are now in edit mode. Use the **Up** (⬆) and **Down** (⬇) buttons to scroll through the character values. See Appendix D for more information

Note: Double click the **Up** (↑) or **Down** (↓) button to move to the top or bottom of the alphabet list. To enter numbers or lower case characters, continue pressing the **Up** (↑) or **Down** (↓) button.

When you have selected the correct character, press **Continue** (→), the cursor will move to the next character position.

Note: The next character will start from the last one selected.

If you are editing a current text string, press **Continue** (→) to accept a character you wish to keep.

To delete characters press the **Back** (←) button, all characters will be deleted to the right of the cursor.

If a text string is deleted in error, double-click the **Back** (←) button to exit the menu item. The original text string will be retained.

Continue entering the rest of the text string. To finish press the **Continue** (→) button once more.

3.8 In the event of an alarm

In the event of an alarm the message display area will display the channel in alarm and the detectors location (if this information has been pre-set in the configuration), the Alarm LED will flash, the internal sounder and any dedicated audible visual alarms will activate, and any external alarm apparatus connected through the channel relays will operate. If more then one channel goes into alarm, the display will cycle through the channels in alarm. Channel display area in the Figure 3.3 shows channel #2=CH4 (methane) in alarm condition. The gas reading will cycle back and forth between the channel type and the gas reading.

Gas detectors

The channel or channels in alarm will display an alarm symbol and flash alternately with the type of the detector in the channel display. Gasmaster provides low and high alarm levels, these levels are user configurable and can be set as rising or falling.

Fire detectors

Fire detectors in alarm will display *FIRE* in the channel display. There is only one level of alarm for fire channels.

Note: pressing the Accept/Reset button to clear alarms from conventional fire detectors removes power from the smoke/heat detector for 2 seconds to reset the device (this 'fire reset time' is adjustable; see page 33). A 2-second 'stabilisation time' is also re-applied to provide time for the detector to settle; the channel warning triangle will show and alarms and relays will remain active during this stabilisation period.

Environmental sampling Units (ESU)

ESU sampling devices that have slowed or stopped will display ESU. Level 1 means slow, level 2 means stopped

To mute the sounder

Press the **Accept/Reset** (↵) button on the operator panel (or remote Accept/Reset switch if fitted). The Alarm LED will stop flashing, but remain lit. The channel display will show the gas reading.

When alarm conditions have cleared, press the **Accept/Reset** (↵) button to clear any latched alarms.



Figure 3.3 Example system in alarm

3.9 mV channels: Pellistor saver mode

In order to protect pellistor-type sensors from damage when exposed to high gas concentrations, flammable gas detectors connected to a mV pellistor input module are protected by a 'Pellistor Saver' mode. If the signal from the sensor exceeds 95%LEL the system removes power from the sensor. The channel will go into fault and the message "Chan #n: pellistor saver mode" will be shown in the Faults menu.

This state latches for 200 seconds, after which it may be manually reset: power is restored to the sensor and the pre-set stabilization period is re-applied to allow the sensor to settle. Alarm relays will remain active during this stabilisation period. It is advisable to check that no flammable gas remains in the area of the detector before re-setting.

Whilst in pellistor saver mode the channel display will display 'or' to indicate the sensor has been exposed to an excessive gas concentration. A horizontal bar sequences top, middle, bottom while the 200 second timer is active, and the centre bar only flashes when the timer is complete and the channel is ready to be reset.

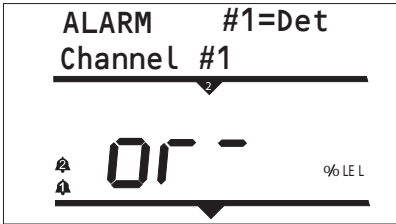

Figure 3.4

Note: it is strongly recommended that sensors are re-balanced and re-calibrated after exposure to high gas concentrations.

Note: the pellistor saver mode can be disabled for each channel if required. The 'Warning' LED will remain active while any channel has pellistor saver disabled; after 15 minutes the pellistor saver function will automatically be re-enabled (it can also be re-enabled at any time using the Supervisor menu).

Functions where Pellistor Saver mode will be disabled:

- When the Pellistor Saver mode is set to 'Disabled' manually.
- When the channel is in 'Inhibit' state (note: when using the Calibration function Pellistor Saver will be enabled if the channel is not inhibited). Note: the channel will remain in Pellistor Saver Disabled mode until it is manually re-enabled or the 15-minute time-out period has lapsed.
- When the 'Sim input' function is used to ramp-up the channel gas reading. Note: the channel will remain in Pellistor Saver Disabled mode until it is manually re-enabled or the 15-minute time-out period has lapsed.

Pellistor Saver mode reverts to 'enabled' after power to the Gasmaster is removed and re-applied.

Refer to Supervisor menu section for details on enabling/disabling the Pellistor saver mode.

3.10 In the event of a fault

In the event of a fault the fault LED will illuminate and the internal sounder will activate. The message area will display **FAULT:** and fault ID number. The fault description will appear in the lower portion of the message area, messages longer than 16 characters will be scrolled across the screen.

Pressing Accept/Reset will clear the fault message from the display. To display a list of all faults present, use the faults menu.

A list of faults can be found in the "Menu system overview" on page 24.

3.11 System Configuration

Your Gasmaster system is supplied pre-configured, however, you may wish to configure relay and alarm settings to suit your requirements or adjust detector values, carry out calibration and other confidence checks. Your Gasmaster system can be configured using the Operator Panel and Menu System. You will find details of the menu structure and configuration options over the next few pages, refer to Figure 3.5 on page 25 for an overview of the menu structure.

To edit your systems configuration you must enter the Supervisor mode which is password protected to prevent miss-use or accidental change. (Refer to section 3.7 for details on entering Supervisor mode.)

For more information on testing your Gasmaster system, please go to section "Maintenance" on page 35.

Gasmaster PC software is available which enables full system configuration from a PC. An optional communications port is required if Gasmaster PC is to be used, contact Crowcon for details.

3.11.1. Re-configuring a channel

Your Gasmaster system is supplied pre-configured, but you may require to re-configure when a detector is changed or a new detector is added. This section provides details on configuring channels, refer to page 33 'Channels #1 to #4' from the Supervisor configuration menu.

3.11.2. Limitations

If Gasmaster is used in a manner not specified in this manual, the protection provided may be impaired.

Menu system overview

Over the next few pages you will find a detailed description of the menu system. Use figure 3.4 as an overall guide to locate menu items.

Gasmaster has five standard menus: Faults, Warnings, View, Actions and Supervisor. Only the Supervisor menu allows you to configure Gasmaster.

This section contains tables that list the menu items for each menu and the available values.

See "Using the Control Panel in Supervisor Mode" on page 21 for instructions on how to alter settings.

Note: The display only shows two lines of information at a time. Use the **Up** (↑) and **Down** (↓) buttons to see additional menu items or values. Use **Continue** (↵) to select choices and **Back** (←) to exit menu.

Faults menu (lists faults present on the system)

Menu Item	Values (as shown on display)	Description	Fault codes
No faults	(end of list)	No faults are present	
Faults	Measurement system failure!	Fatal fault, contact Crowcon.	1 or 2
	Warning - Battery low	Input supply has failed and internal battery supply has dropped to 22 volts.	4
	Relay power supply fail	Power rail to the relays has failed and relays will no longer operate. Contact Crowcon	5
	Main supply fail	Main supply has failed and the system is running on batteries	6
	NVM hardware fail	Fatal fault, contact Crowcon.	7
	Loaded default settings	System has returned to standard configuration settings. Re-configure using the Supervisor menu.	8
	Common relay fail	Coil fault detected. Contact Crowcon	9, 10, 11
	Chan #1 relay fail	Channel relay coil fault detected. Contact Crowcon.*	12 to 19
	ESU #1 stalled!	ESU sampling device has stopped.*	20 to 23
	ESU #1 slow!	ESU sampling device has slowed.*	24 to 27
	Chan #1 over range	Detector input signal is over 21.5 mA. Investigate cause at detector taking necessary precautions as high gas levels may be present.*	28 to 31
	Chan #1 under range	Detector input signal is under 3 mA. Check detector.* If the 'Interpret 2 mA' command is set to Warning or Inhibit in the channel configuration, this fault message will display when the input signal drops below 1mA.	32 to 35
	Chan #n: pellistor saver mode	mV pellistor type detector has been exposed to gas in excess of 95%LEL. A 200-second timer will be applied, after which the fault may be reset	36-39

* #1 denotes the channel number and therefore may read #2, #3 or #4 on Gasmaster.

The fault codes are numbered to relate to a particular channel where appropriate (e.g. fault code 19 means there is a fault on Channel 4 Level 2 alarm relay).

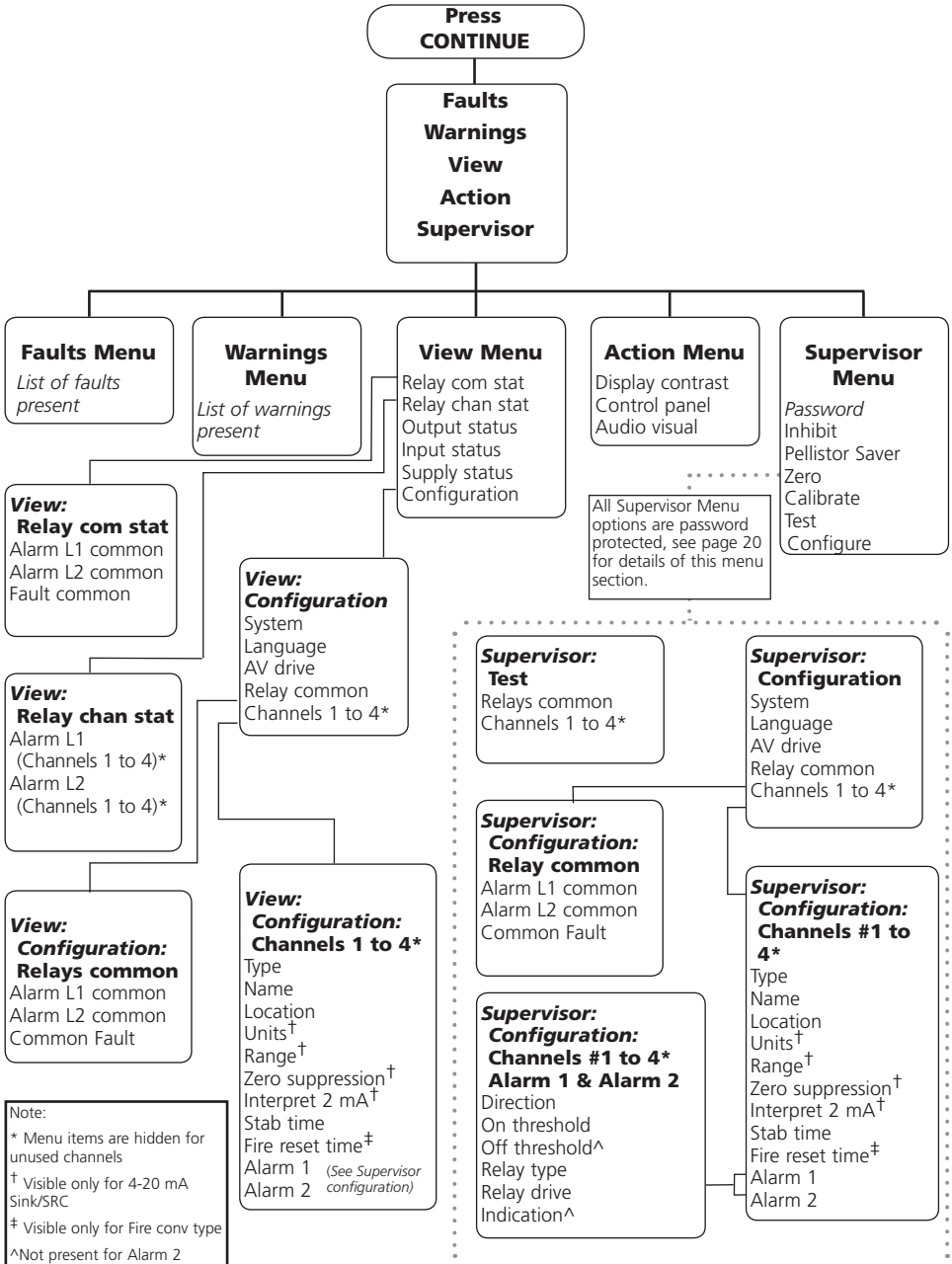

Figure 3.5 Overview of Gasmaster Menu system

Warnings menu (lists warnings present on the system)

Menu Item	Values (as shown on display)	Description	Codes
No warnings	(end of list)	No warnings are present.	
Warnings	Supervisor mode	System configurations may be changed.	1
	Global inhibit	All input channels are inhibited.	2
	Testing audio visual alarm	Audible visual outputs will be driven.	3
	Service/calibration due	Service or calibration interval has expired.	4
	Common relay forced	Common alarm or fault relays are being forced to their 'alarm' state.	5, 6, 7
	Main Supply Fail	Main supply has failed and the system is running on batteries	8
	Detector #1 stabilising	Detector is currently in its stabilisation or reset period*, (see page 30).	9, 17, 25, 33
	Detector #1 input low	Detector input signal is between 1 and 3 mA.* Only applies when the 'Interpret 2 mA' command is set to Warning in the channel configuration.	10, 18, 26, 3
	Detector #1 initiated inhibit	A 2 mA inhibit signal has been received from a detector.* Only applies when the 'Interpret 2 mA' command is set to Inhibit in the channel configuration.	11, 19, 27, 35
	Chan #1 inhibited	Input channel is in an inhibit state* .	12, 20, 28, 36
	Chan #1 input simulated	Channel input is being forced in Test mode.*	13, 21, 29, 37
	Chan #1 output forced	Channel analogue output is being forced in Test mode.*	14, 28, 30, 38
	Chan #1 relay forced	Channel alarm relay is being forced in Test mode.*	15, 16, 23, 24 31, 32, 39, 40
	Chan#1 pellistor saver disabled	Pellistor saver mode has been disabled, the sensor may be damaged if exposed to gas concentrations above 100%LEL.	41,42,43,44

* #1 denotes the channel number and therefore may read #2, #3 or #4 on Gasmaster.

View menu (shows system status and configuration, but does not allow changes to be made.)

Menu Item	Values (as shown on display)	Description
Relay com stat	Alarm L1 common Values = No alarm In alarm Alarm L2 common Values = No alarm In alarm Fault common Values = No alarm In alarm	L1 = Level 1. L2 = Level 2 The 'values' show the current state of each relay (relays may be normally energised or de-energised dependant on configuration): 'No alarm' means the relay is in its normal state. 'In alarm' means the relay is in its alarm or fault state.
Relay chan stat	Alarm L1 #1 Values = No alarm In alarm Alarm L2 #1 Values = No alarm In alarm	#1 refers to the input channel, use the Down button to scroll to channels #2, #3, #4 if appropriate. L1 = Level 1. L2 = Level 2 (use the down key to view level 2). The 'values' show the current state of each relay (relays may be normally energised or de-energised dependant on configuration): 'No alarm' means the relay is in its normal state. 'In alarm' means the relay is in its alarm state.
Output status	Output #1 Values = 0.0 to 25.5 mA	#1 refers to the input channel, use the Down button to scroll to channels #2, #3, #4 if appropriate. The 'values' show the current analogue output level for a channel.
Input status	Input #1 Values = 0.0 to 66.7 mA,	#1 refers to the input channel, use the Down button to scroll to channels #2, #3, #4 if appropriate. The 'values' show the current signal input level for a channel.
Supply status	Supply Value = 19.8 to 40 V	Indicates the DC supply level from either the internal PSU or an external DC supply.
Configuration	See table <i>Supervisor menu</i> :	

* #1 denotes the channel number and therefore may read #2, #3 or #4 on Gasmaster.

Actions menu (allows basic tests and adjustments.)

Menu Item	Values (as shown on display)	Description
Audio visual	Audio Visual: Test alarm? Values = Testing beacon Testing alarm L1 Testing alarm L2 Test complete	Drives Audible Visual alarm terminals to test external audible visual alarms Beacon output becomes active for 3 seconds, followed by; Sounder level 1 output becomes active for 3 seconds, followed by; Sounder level 2 output becomes active for 3 seconds, followed by; Outputs de-activate and display returns to the Audio Visual menu
Control panel	Control Panel: Start test? Test complete	Press Continue to test LCD display, LED's and internal sounder for 3 seconds. Display returns to Control Panel menu
Display contrast	Display: Values = Menu contrast Channel contrast	Alters the message display area contrast Use the Up and Down buttons to adjust the contrast of the LCD

Supervisor menu (allows system tests to be performed, and configurations to be changed. A pass word is required to enter this mode, see section 3.7 for details.)

Menu Item	Values (as shown on display)	Description
Inhibit	All Values = Inhibit off Inhibit on Channels #1, #2, #3, #4 Values = Inhibit off Inhibit on	Inhibits all input channels when selected. Only whilst in Supervisor mode used for calibration and test Allows individual channels to be inhibited. NB: Inhibit persists on exit from Supervisor mode
Pellistor Saver	Channels #1, #2, #3, #4 Values = Enabled or Disabled	Protects pellistor-type sensors connected to mV pellistor input modules from damage when exposed to high gas concentrations. When enabled, the system removes power from the sensor for a minimum 200 seconds if the signal exceeds 95%LEL.
Zero	Zero Wizard Select channel Values = #1=name #2=name #3=name #4=name Select channel Inhibit Values = Inhibit on Inhibit off <i>User confirmation</i> Only continue if in clean air! Result Values = Pass Fail	Use Down button to select the required channel to zero, then follow wizard instructions. Inhibit option will not be displayed if channels have already been set to inhibit using the menu shown above. Reminds the user to check that the detector has been zeroed and is currently not seeing gas. Channel has correctly zeroed Input signal was out of acceptable range, re-zero the detector and check that its output current is 4 mA.
Calibrate	Calibration Wizard Select channel Values = #1=name #2=name #3=name #4=name Cal #1 level Values = 25% - 100% of range Select channel Inhibit Values = Inhibit on Inhibit off	Use Down button to select the required channel to calibrate, then follow wizard instructions. Refers to the calibration gas concentration Calibration is only possible with a gas concentration that is at least 25% of the full range of the sensor. Use the UP and Down buttons to enter the concentration of the calibration gas (e.g. 50% LEL, 10 ppm etc.). Gasmaster will store the gas value entered so that it does not need to be adjusted next time the sensor is calibrated. Inhibit option will not be displayed if channels have already been set to inhibit using the Inhibit menu.

Supervisor menu (allows system tests to be performed, and configurations to be changed. A pass **cont.** word is required to enter this mode, see section 3.7 for details.)

Menu Item	Values (as shown on display)	Description
Calibrate	<p><i>User action</i> Apply gas</p> <p><i>User confirmation</i> Continue when reading is stable</p> <p>Calibration Wizard cont.</p> <p><i>Result</i> Value = Pass Fail</p> <p><i>User action</i> Purge gas</p>	<p>Apply gas and calibrate the detector.</p> <p>Press Continue when the detector has been calibrated and is providing the correct output signal.</p> <p>Channel has correctly calibrated.</p> <p>Input signal was out of acceptable range, re-calibrate the detector and check that its output current is proportional to the gas level</p> <p>Reminds the user to remove the calibration gas and re-expose the detector to clean air.</p>
Test Use to simulate inputs and outputs for testing and commissioning purposes.	<p>Relay common</p> <p>Relay alarm L1 Alarm L1 common Values = No alarm In alarm</p> <p>Relay alarm L2 Alarm L2 common Values = No alarm In alarm</p> <p>Fault Fault common Values = No fault In fault</p>	<p>Forces common level 1, 2 or Fault relays. L1 = Level 1. L2 = Level 2</p> <p>The 'values' show the current state of each relay (relays may be normally energised or de-energised dependant on configuration): 'No alarm' or 'No fault' means the relay is in its normal state. 'In alarm' or 'In fault' means the relay is in its alarm or fault state.</p> <p>Use the Up and Down buttons to change the relay state, press Back to exit, the relay will return to its normal state</p>
	Channel #1, #2, #3, #4	<p>Use the Up and Down buttons to select the desired channel. The channel warning symbol Δ will show. Channel alarm relays can be tested as described above.</p>
	<p>Sim Input #1 Values = 0.0 - 25.5 mA 0.0 - 66.7 mA for fire detectors</p> <p>Force output #1 Values = 0.0 - 25.5 mA</p>	<p>When selected, displays the input signal level for the selected channel (e.g. 4.1 mA). The channel warning symbol Δ will show. Use the Up and Down buttons to force the input to the required level. The reading on the channel display will change accordingly and alarms will activate at the preset points. Use the Accept/Reset button to silence alarms if necessary. Press Back to exit, the input will return to its normal state.</p> <p>When selected, displays the analogue output signal level for the selected channel (e.g. 4.1 mA). The channel warning symbol Δ will show. Use the Up and Down buttons to force the output to the required level.</p>

Supervisor menu (allows system tests to be performed, and configurations to be changed. A pass **cont.** word is required to enter this mode, see section 3.7 for details.)

Menu Item	Values (as shown on display)	Description
	Relay alarm L1 Values = No alarm In alarm Relay alarm L2 Values = No alarm In alarm	No alarms will be activated on Gasmaster. Use to test remote displays. Press Back to exit, the input will return to its normal state. Forces level 1, 2 relays for the selected channel. The channel warning symbol Δ will show. Contact orientation will depend on whether the relay is configured as normally energised or de-energised. Press Back to exit, the relay will return to its normal state.
Configure Use to change system settings	Select from config sub menus below	
System	ModBus addr Values = 1 to 254 Serial comms Values = 9600, 8, N, 1 9600, 8, N, 2 Identity Values = 16 character string Mains Fail Values = AS WARNING AS FAULT	Required for RS-485 digital communications only, any address in the range can be chosen. If multiple units are connected on an addressable loop to a 'Master' controller, each Gasmaster must have a different address. Describes the required RS-485 communications parameters; Gasmaster is factory set to 2 stop bit. Allows a system name to be entered which will be shown on the Gasmaster display when the appropriate mode is selected (see section 3.4). Use the Up and Down buttons to enter required alpha-numeric characters and press Continue to accept. Determines whether a main supply fail is treated as a fault or a warning
Language	Language Values = English (UK) configurable	The default display language is English. A second language may be available depending on system configuration.
AV drive	Beacon type Values = Latched Non-latched Sounder type Values = Latched Non-latched	Determines the operation of beacons connected to the 'AV1 Drive' terminal. Latched means that in an alarm state, the beacon will continue flashing when the Accept/Reset button is pressed, and will only stop flashing when the alarm is cleared and the Accept/Reset button is pressed again. Non-latched means that the beacon will continue flashing when the Accept/Reset button is pressed, but stop automatically when non-latching alarms have reset. Determines the operation of sounders connected to the 'AV2/3 Drive' terminals. Latched means that in an alarm state, the sounder

Supervisor menu (allows system tests to be performed, and configurations to be changed. A pass **cont.** word is required to enter this mode, see section 3.7 for details.)

Menu Item	Values (as shown on display)	Description
AV drive cont.	Latch-accept	<p>will continue to operate when the Accept/Reset button is pressed, and will only stop sounding when the alarm is cleared and the Accept/Reset button is pressed again.</p> <p>Non-latched means that the sounder will continue to operate when the Accept/Reset button is pressed, but will silence automatically when the alarm has cleared.</p> <p>Latch-accept means that in an alarm condition the sounder will silence when the Accept/Reset button is pressed.</p>
Relay common	<p>Alarm L1 common Type Alarm 1 type Values = Latched Non-latched Latch-accept Drive Alarm 1 drive Values = De-energised Energised</p> <p>Alarm L2 common Type Alarm 2 type Values = Latched Non-latched Latch-accept Drive Alarm 2 drive Values = De-energised Energised</p> <p>Fault common Type Fault type Values = Latched Non-latched Drive Fault drive Values = De-energised Energised</p>	<p>Determines the operation of the common alarm and fault relays.</p> <p>L1 = Level 1. L2 = Level 2</p> <p>Latched means that in an alarm state, the relay will stay active when the Accept/Reset button is pressed, and will only reset when the alarm or fault has cleared and the Accept/Reset button is pressed again.</p> <p>Non-latched means that the relay will stay active when the Accept/Reset button is pressed, but will reset automatically when the alarm has cleared.</p> <p>Latch-accept means that in an alarm or fault condition the relay will reset when the Accept/Reset button is pressed.</p> <p>De-energised means that the relay coil is not energised in a non-alarm state (normally de-energised).</p> <p>Energised means that the relay coil is energised in a non-alarm state (normally energised or 'fail-safe')</p>

Supervisor menu (allows system tests to be performed, and configurations to be changed. A pass **cont.** word is required to enter this mode, see section 3.7 for details.)

Menu Item	Values (as shown on display)	Description
<p>Channels #1 to #4 Press the Up and Down Config Channel #1 buttons to cycle through configuration for channels #2, #3 and #4.</p> <p>Channels #1 to #4 Cont.</p> <p>*Options will be shown for 4-20 mA input channels only</p> <p>*Options will be shown for 4-20 mA input channels only</p>	<p>Type Values = Unused DET 4-20 SRCE DET 4-20 SINK FIRE 4-20 SRCE FIRE 4-20 SINK FIRE CONV ESU PELLISTOR</p> <p>Name Values = 4 character string</p> <p>Location Values = 32 character string</p> <p>Units* Values = None %LEL PPB PPM %VOL FIRE</p> <p>Range* Values = 0 to 9999.9</p> <p>Zero suppression (ZFS)* Values = Enabled Disabled</p> <p>Interpret 2mA* Values = Fault Warning Inhibit</p> <p>Stab time Values = 0 to 120 seconds</p> <p>Fire reset time** Values = 0 to 30 seconds Alarm L1 #1, #2, #3, #4 See submenu below</p>	<p>Sets the input type for each channel, links on the terminal PCB must also be set to the appropriate positions (see section 2.8 for details).</p> <p>No detector connected 4-20mA current source gas detector 4-20mA current sink gas detector 4-20mA current source flame detector 4-20mA current sink flame detector Conventional smoke/heat or call points ESU sampling device mV Pellistor input modules and detectors only</p> <p>Detector name (e.g. CH4 for methane, O2 for oxygen, FIRE for smoke/heat detectors)</p> <p>Optional. Detector location or tag, will be shown on the message display if an alarm occurs (e.g. Boiler Room).</p> <p>E.g. for an ESU channel For flammable channels Very low range toxic gas detectors General toxic gas detectors Oxygen or other high volume gases Flame or conventional smoke/heat detectors.</p> <p>Detector range (e.g. 100 for a flammable detector).</p> <p>Applies suppression to the first 3% of scale to prevent small deviations from zero being displayed. If the Level 1 alarm for a channel is set below 8% of full scale, the level of suppression is reduced.</p> <p>Some gas detectors produce a 2 mA signal to indicate a certain state. This option determines how Gasmaster interprets a signal between 1 and 3 mA.</p> <p>Inhibits the input for preset time after Gasmaster is powered-up to prevent false alarms while the sensor is settling.</p> <p>Time for which power is removed from smoke/heat detectors when the Accept/Reset button is pressed.</p>

** Option will be shown for conventional fire channels only

Supervisor menu (allows system tests to be performed, and configurations to be changed. A pass **cont.** word is required to enter this mode, see section 3.7 for details.)

Menu Item	Values (as shown on display)	Description
<p>Config channel Submenu:</p> <p>Alarm L1 #1</p> <p>Level 1 alarm relay configuration for each channel</p> <p>Press the Up and Down buttons to cycle through configuration for channels #2,#3,#4</p>	<p>Direction Values = Rising Falling</p> <p>On threshold Values = 0.1 to Range (full scale)</p> <p>Off threshold Values = 0.1 to L1 On threshold (rising alarms) L1 threshold to full scale - 0.1 (Falling alarms)</p> <p>Relay type Values = Latched Non-latched Latch accept</p> <p>Relay drive Values = De-energised Energised</p> <p>Indication Values = Visible Hidden</p>	<p>Rising alarms required where there is normally no gas. Falling alarms required where gas should normally be present (e.g. oxygen).</p> <p>Level at which the relay will activate.</p> <p>Level at which the Level 1 relay will reset. Allows hysteresis for applications such as ventilation control where the fan should continue to run until the gas reaches a low level.</p> <p>Latched means that in an alarm state, the relay will stay active when the Accept/Reset button is pressed, and will only reset when the alarm or fault has cleared and the Accept/Reset key is pressed again.</p> <p>Non-latched means that the relay will stay active when the Accept/Reset key is pressed, but will reset automatically when the alarm has cleared.</p> <p>Latch-accept means that in an alarm condition the relay will reset when the Accept/Reset button is pressed.</p> <p>De-energised means that the relay coil is not energised in a non-alarm state (normally de-energised).</p> <p>Energised means that the relay coil is energised in a non-alarm state (normally energised or 'fail-safe')</p> <p>Visible means that an alarm will trigger the alarm LED bar, internal sounder, external audible visual alarms, and display the alarm message.</p> <p>Hidden means that an alarm will only cause the alarm icon  in the channel display to show. No other audible or visual alarms will activate (used for ventilation control applications)</p>
<p>A similar menu is available for Level 2 alarm relays, with the exception that the 'Off Threshold' and 'Indication' options are not available.</p>		
<p>Alarm L2 #1*</p>	<p>Direction</p> <p>Threshold</p> <p>Relay type</p> <p>Relay drive</p>	

* #1 denotes the channel number and therefore may read #2, #3 or #4 on Gasmaster.

4. Maintenance

It is essential that any safety system such as Gasmaster is routinely checked. Crowcon offer service contracts to ensure that this equipment is fully operational at all times. As a minimum, Crowcon recommend that systems are calibrated and tested on a six-monthly basis. Sensors should be changed as advised in the detector manual.

Note: a 'calibration due' warning message may be flagged six months after the last service*. The warning LED \triangle will light and the message will be shown in the "Warnings menu (lists warnings present on the system)" on page 26. This message can be reset using Gasmaster PC, which also allows the period after which the message is displayed to be adjusted.

*Or when the system was last powered-up.

4.1 Functional Testing

Gasmaster allows you to test relays, force inputs into alarm state, and force analogue outputs to verify the correct operation of the Gasmaster system and its interfaces with external equipment. These functions are available in the *Supervisor* menu under *Test*.

Please note that using this function will activate the appropriate relays, audible visual alarm drives and analogue outputs. Ensure necessary precautions are taken prior to using test functions.

The options available in *Test* can be found in section 3.11 on page 23, along with a description of each function.

4.2 System Inhibit

Inputs can be temporarily inhibited so as not to cause alarms. This may be necessary when calibrating detectors, or when operations are carried out close to a sensor which may trigger an alarm (for example soldering near a smoke detector). Input channels can be inhibited individually or all at once. The 'inhibit' option is available in the *Supervisor* menu, see section 3.6 on page 20 and the Menu System Overview on page 25 in the *Operation* chapter for details of this function.

If it is necessary to permanently disable a channel,

enter *Supervisor* mode and set the relevant detector Type to *Unused* (see page 33). The channel display will be no longer shown, and the power supply will be removed from the detector.

Warning

Crowcon strongly recommends that remote inhibit switches be key operated only, and that access to the key should be restricted to authorised personnel. A Gasmaster system that has been inhibited without other safety precautions being in place may not provide the protection for which it was designed. Steps should be taken to ensure that all appropriate personnel are aware when a Gasmaster system is inhibited.

How to perform Inhibit

1. From the normal operating display, press the **Continue** \odot button to enter the menu system.
2. Use the **Up** \uparrow and **Down** \downarrow buttons as necessary to select **Supervisor** and press **Continue** \odot .
3. Enter the password (the default password is ZZZ), press **Continue** \odot .

See section 3.7 in *Operation* for details on entering *Supervisor mode*.

4. How to set global inhibit:

From the **Supervisor** menu, scroll down to *Inhibit* and press **Continue** \odot . Select **All** and press **Continue** \odot . Use the **Up** \uparrow or **Down** \downarrow button to set inhibit to **INHIBIT ON**, press **Continue** \odot to accept. Use the **Back** \leftarrow button to return to the **Supervisor** menu. The *Inhibit* icons will appear on the channel display.

How to set channel inhibit:

Channel inhibit can be selected from the **Inhibit** menu or within the **Zero** or **Calibrate** menu. Follow the instructions provided above, selecting the **Channel #n** (where n represents the channel number) in place of **All**.

Ensure all inhibits are removed when maintenance activities are complete.

4.3 Detector Calibration

Crowcon recommends that you check detectors routinely to ensure correct calibration and operation.

Gas detectors require recalibration at least every 3 to 6 months. Fire detectors should be tested with the same frequency. Site procedures may require more frequent testing. See section 2.12 on page 14 for calibration instructions.

For detailed instructions on the routine functional testing of detectors, please refer to the relevant Installation, Operating and Maintenance Instructions provided with each detector.

4.4 Changing Batteries

During routine servicing, it is recommended that the power be isolated from Gasmaster temporarily to ensure that the back-up batteries are operational. Crowcon recommend that batteries are changed every two years, and replaced as a pair.

Replacement batteries should be Yuasa UCEL Y1.2-12, 12 v 1.2 Ah C20 lead-acid type cells.

A 10 A fuse is fitted to the batteries, for replacement part number see Spare Parts and Accessories section.

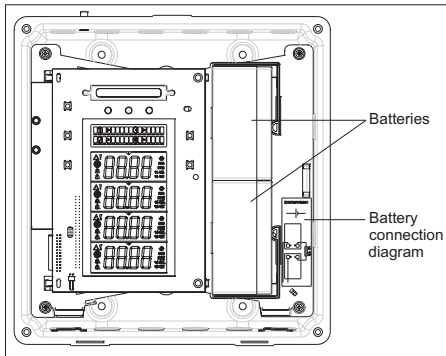

Figure 4.1 Battery replacement

Batteries should be checked regularly on units operating over 40°C.

Warning

When replacing batteries, care should be taken to ensure cables are re-fitted as shown on the battery connection diagram. Incorrect fitment of battery cables may result in a fire and/or harm to personnel.

4.5 Module Replacement

In the unlikely event of a Gasmaster component failure, Crowcon recommend that repair should not be undertaken by anyone other than Crowcon approved personnel. Please contact Crowcon for details of your nearest service centre.

4.6 Event logging

Gasmaster records alarms, faults and display panel button activities in an Event Log. A maximum of 300 events are logged, after which data is over-written on a first-in-first-out basis. This function provides a record of all system activities which can be uploaded using Gasmaster PC software at any time.

The event log is held in RAM (volatile memory), so in the event of a complete power failure all data will be lost.

4.7 Service card

A card is fitted to the inside of the front cover for logging service activity. It is recommended that this card be filled in with the dates of services, and details of any parts replaced.

4.8 Cleaning

If required, the outside of the Gasmaster case can be cleaned by gently wiping with a damp cloth using a mild soap solution only.

5. Adding an input module

The 4-channel version of Gasmaster may be supplied pre-fitted with between one and four input modules of the following types:

- 4-20 mA/Fire module for 4-20 mA type detectors, conventional smoke/heat detectors or ESU.
- mV Pellistor module for mV bridge type flammable gas detectors.

Systems ordered with fewer than four input modules can be extended at a later date by fitting additional modules. The input modules simply plug-in, it is not necessary to remove power from the system providing the channel is set as 'Unused' prior to insertion.

Once the module has been added the channel can be configured as appropriate to the detector using the Supervisor menu.

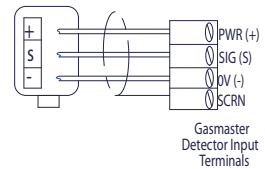
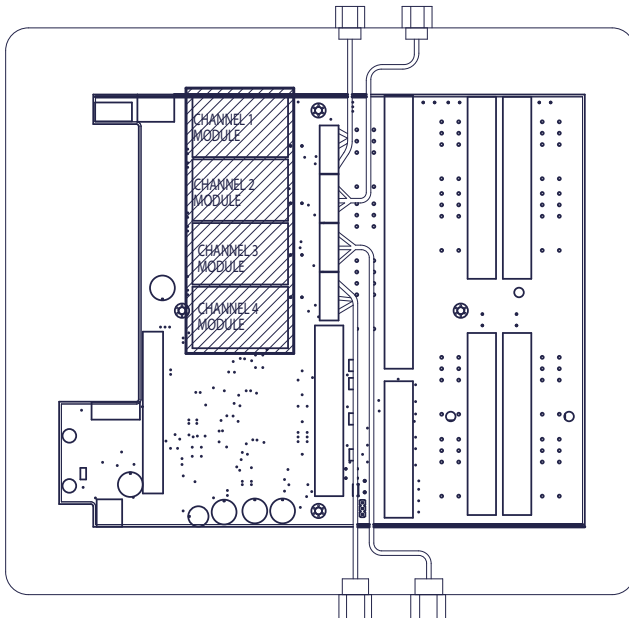

mV pellistor gas detector

Important: to avoid signal interference, it is essential that detector cables do not cover mV pellistor input modules (hatched area on diagram).

Figure 5.1 Connections for mV pellistor type detectors. mV Pellistor input module

Appendix A: Specifications

	Gasmaster 1	Gasmaster 4
Size	288h x 278w x 110d (mm)	288h x 278w x 110d (mm)
Weight	4.5 kg	4.5 kg
Enclosure material	Back-box: cast aluminium Front cover: fire-retardant ABS plastic.	Back-box: cast aluminium Front cover: fire-retardant ABS plastic.
Ingress protection	IP65	IP65
Power	100-240 V ac 50-60 Hz 1.3 A or 20-30 V dc, 60 W max.	100-240 V ac 50-60 Hz 1.3 A or 20-30 V dc, 60 W max.
Battery back-up	1.2 Ah batteries fitted internally	1.2 Ah batteries fitted internally
Operating temperature	-10°C to + 50°C (14 to 122°F).	-10°C to + 50°C (14 to 122°F).
Humidity	0 to 95% RH non-condensing	0 to 95% RH non-condensing
Input: Gas	One 2 or 3 wire 4-20 mA gas detector (sink or source) or mV bridge pellistor flammable gas detector. Maximum detector current: 500 mA	One to four 2 or 3 wire 4-20 mA gas detectors (sink or source) or mV bridge pellistor flammable gas detectors. Maximum detector current: 500 mA
Fire	One loop of up to 20 conventional smoke/heat detectors or manual call points, or one flame detector (4-20 mA or digital contact signal).	One to four loops of up to 20 conventional smoke/heat detectors or manual call points, or one to four flame detectors (4-20 mA or digital contact signal).
Environmental Sampling Unit control	For use with one Crowcon ESU fan (ie 'sampling device' changes to 'fan').	For use with one to four Crowcon ESU fans.
Remote inhibit	Via normally open contact.	Via normally open contact.
Remote reset	Via normally open contact.	Via normally open contact.
Outputs: Relays	Low alarm, High alarm, Fault. DPCO contacts rated at 250 V ac, 30 V dc 8 A (non-inductive load), 5 A (inductive load).	Low alarm and High alarm per channel plus Common Low, High and Fault. DPCO contacts rated at 250 V ac, 30 V dc 8 A (non-inductive load), 5 A (inductive load).
Audible/visual alarm drive	12 V or 24 V dc 650 mA maximum drive	12 V or 24 V dc 650 mA maximum drive
Analogue	4-20 mA (current source, max. loop resistance 700 Ω) or 1-5 V dc (min. load 50 KΩ).	4-20 mA for each channel (current source, max. loop resistance 700 Ω) or 1-5 V dc (min. load 50 KΩ).
Digital communications	RS-485 Modbus RTU 9600 Baud 8 Data bits No parity 2 Stop bits	RS-485 Modbus TRU 9600 Baud 8 Data bits No parity 2 Stop bits
Communications port	Optional 3-way connector for PC configuration and event log upload	Optional 3-way connector for PC configuration and event log upload
Event logging¹	Time-stamped log of up to 300 alarm, fault or system intervention activities.	Time-stamped log of up to 300 alarm, fault or system intervention activities.
Panel indication	LCD back-lit display shows gas level (in ppb, ppm, % volume or % LEL units), and scrolling alphanumeric status indication. LEDs for Alarm, Fault, Power and Warning status indication. Integral 85 dB sounder.	LCD back-lit display shows gas level (in ppb, ppm, % volume or % LEL units) for all channels, and scrolling alphanumeric status indication. LEDs for Alarm, Fault, Power and Warning status indication Integral 85 dB sounder.
Approvals	EN 50270 (EMC), EN 61010-1 (Low voltage directive) ATEX EN60079-25:2010 Explosive atmospheres - Intrinsically safe electrical systems.	EN 50270 (EMC), EN 61010-1 (Low voltage directive) ATEX EN60079-25:2010 Explosive atmospheres - Intrinsically safe electrical systems.

¹Event log access requires Gasmaster PC software and communication port. Event log data is held in non-volatile memory, data will be lost in the event of a complete system power failure.

Appendix B: Spare Parts and Accessories

Part No.	Description	Comment
E01875	12V 1.2Ah battery	2 required
E07534	Battery fuse assembly	Assembly with fuse, fuse holder and loom
M05897	Service card	Replacement service cards, minimum quantity 10
M07624	Installation, Operation and maintenance manual	
S012016	Display PCB	For all Gasmaster models
S013047	Gasmaster 4 terminal PCB	No links supplied, use links from old PCB
S013046	Gasmaster 1 terminal PCB	No links supplied, use links from old PCB
E07109	Insulated Jumper links	Spare links for PCB's, minimum order quantity 10
S012304	Power supply assembly	Complete with wiring looms
S012205	Sounder assembly	Complete with wiring loom
M04683	Sounder seal	
M050067	Gasmaster 4 display label	For front cover
M050068	Gasmaster 1 display label	For front cover
C01929	Communications Kit	Includes Gasmaster PC software, connection lead and RS485/232 converter.
E07635	Communications port	3-pin connector for fitment to Gasmaster to enable interface with the Communications Kit. Comes complete with wiring loom for connection to the RS-485 terminals.
S012303	Front cover assembly for Gasmaster 1	Complete with labels, sounder and seals
S012302	Front cover assembly for Gasmaster 4	Complete with labels, sounder and seals
M01861/2	Flush mounting brackets	For mounting Gasmaster into a panel.
S012207	4-20mA/Fire input module	
S012208	mV Pellistor input module	

Appendix C: Display characters

Message display area characters

When editing strings of text for passwords, detector location or system identity, the following characters are available:

- Group1: <space> !
- Group2: # \$ % &
- Group3: * + , - . /
- Group4: 0 1 2 3 4 5 6 7 8 9
- Group5: : ;
- Group6: ? @
- Group7: A B C D E F G H I J K L M N
O P Q R S T U V W X Y Z
- Group8: _
- Group9: a b c d e f g h i j k l m n o
p q r s t u v w x y z

Use the Up and Down buttons as described in section 3.7 to select the required characters.

For some string types the available characters may be restricted, only the applicable characters will be shown. For example the detector name (e.g. gas type) is restricted to groups 4 and 7 (numerals and upper case) only:

single clicking or holding the Up button will advance forward through the available groups of characters:

A B C D ... X Y Z 0 1 2 ... 7 8 9 A B C ... etc

single clicking or holding the Down button will advance backwards through the available groups of characters:

Z Y X W ... C B A 9 8 7 ... 2 1 0 Z Y X ... etc

double clicking the Up button will jump forwards to the end of the current group then on to the start of the following one etc: Z 0 9 A Z ...

double clicking the Down button will jump backwards to the start of the current group then on to the end of the following one etc: A 9 0 Z A ...

Channel display characters

NB: The following characters represent those which can be shown on the channel display area to represent detector types.

The following characters cannot be closely represented: K, M, V, W, X

0	A	K	U	b7
1	B	L	V	b5 b1 b3 b6 b2
2	C	M	W	b0 dp b4
3	D	N	X	
4	E	O	Y	
5	F	P	Z = 2	
6	G = 9	Q	dash	
7	H	R	underscore	
8	I	S = 5	?	
9	J	T	blank	

Warranty Statement

This equipment leaves our factory fully tested and calibrated. If within the warranty period of one year from Despatch, the equipment is proved to be defective by reason of faulty workmanship or material, we undertake at our discretion either to repair or replace it free of charge, subject to the conditions below.

Warranty Procedure

To facilitate efficient processing of any claim, contact our customer support team on +44 (0)1235 557711 with the following information:

- Your contact name, phone number, fax number and email address.
- Description and quantity of goods being returned, including any accessories.
- Instrument serial number(s).
- Reason for return.

Obtain a Returns form for identification and traceability purpose. This form may be downloaded from our website 'www.crowcon.com', along with a returns label, alternatively we can 'email' you a copy.

Instruments will not be accepted for warranty without a Crowcon Returns Number ("CRN"). It is essential that the address label is securely attached to the outer packaging of the returned goods.

The guarantee will be rendered invalid if the instrument is found to have been altered, modified, dismantled, or tampered with. The warranty does not cover misuse or abuse of the unit.

Any warranty on batteries may be rendered invalid if the use of an unauthorized charger is proven. Non-rechargeable batteries are excluded from this warranty.

Warranty Disclaimer

Crowcon accept no liability for consequential or indirect loss or damage howsoever arising (including any loss or damage arising out of the use of the instrument) and all liability in respect of any third party is expressly excluded.

This warranty does not cover the accuracy of the calibration of the unit or the cosmetic finish of the product. The unit must be maintained in accordance with the Operating and Maintenance Instructions.

The warranty on replacement consumable items (such as sensors) supplied under warranty to replace

faulty items, will be limited to the unexpired warranty of the original supplied item.

Crowcon reserves the right to determine a reduced warranty period, or decline a warranty period for any sensor supplied for use in an environment or for an application known to carry risk of degradation or damage to the sensor.

Our liability in respect of defective equipment shall be limited to the obligations set out in the guarantee and any extended warranty, condition or statement, express or implied statutory or otherwise as to the merchantable quality of our equipment or its fitness for any particular purpose is excluded except as prohibited by statute. This guarantee shall not affect a customer's statutory rights.

Crowcon reserves the right to apply a handling and carriage charge whereby units returned as faulty, are found to require only normal calibration or servicing, which the customer then declines to proceed with.

For warranty and technical support enquiries please contact:

Customer Support

Tel: +44 (0) 1235 557711

Fax: +44 (0) 1235 557722

Email: customersupport@crowcon.com

Regional addresses

UK Office

Crowcon Detection Instruments Ltd
172 Brook Drive,
Milton Park,
Abingdon
Oxfordshire
OX14 4SD

Tel: +44 (0) 1235 557700

Fax: +44 (0) 1235 557749

Email: crowcon@crowcon.com

Website: <http://www.crowcon.com>

USA Office

Crowcon Detection Instruments Ltd
1455 Jamike Ave.
Erlanger
KY 41018
USA

Tel: +1 859 957 1039 or 1 800 527 6926

Fax: +1 859 957 1044

Email: salesusa@crowcon.com

Website: <http://www.crowcon.com>

Rotterdam Office

Crowcon Detection Instruments Ltd
Vlambloem 129
3068JG, Rotterdam
Netherlands

Tel: +31 10 421 1232

Fax: +31 10 421 0542

Email: eu@crowcon.com

Website: <http://www.crowcon.com>

Singapore Office

Crowcon Detection Instruments Ltd
Block 194 Pandan Loop
#06-20 Pantech Industrial Complex
Singapore 128383

Tel: +65 6745 2936

Fax: +65 6745 0467

Email: sales@crowcon.com.sg

Website: <http://www.crowcon.com>

Crowcon Detection Instruments Ltd (Beijing)

Unit 316, Area 1, Tower B, Chuangxin Building
Hongda North Road, Beijing Economic
Technological Development Area
Beijing, China 100176

Tel: +86 10 6787 0335

Fax: +86 10 67874879

Email: saleschina@crowcon.com

Website: www.crowcon.cn



Crowcon Detection Instruments Ltd

172 Brook Drive,
Milton Park,
Abingdon
Oxfordshire
OX14 4SD

Tel: +44 (0) 1235 557700

Fax: +44 (0) 1235 557749

Email: crowcon@crowcon.com

Website: <http://www.crowcon.com>